

Red Spot offset bolted tags fuse links



Product description

Eaton's Bussmann® series Red Spot offset bolted tags BS fuse links (in sizes A1 to A4) are specifically designed for the protection of general industrial applications, e.g. power distribution, cable protection, motor protection.

Features

- Good peak and let-through current limitation
- 1:1.6 Selective coordinate ratio between 'minor' and 'major' fuse
- gM type offer enhanced motor starting capability
- Power loss values well within the limits of IEC 60269-2

Catalogue symbol:

- NIT(amp)
- NET(amp)
- TIA(amp)
- TIS(amp)
- TCP(amp)
- TFP(amp)

Standard/Agency information:

- BS88-2
- IEC 60269-2

Breaking range and utilisation category:

- gG
- gM

Technical data:

- Breaking capacity: AC: ASTA 20 certified to 80 kA, generally at 660 Volts a.c. to BS88-2 1988 (IEC 60269-2)
- Minimum interrupting rating: $1.6 \times I_n$

Packaging:

- NIT, NET, TIA and TIS: 20
- TCP and TFP: 10

Red Spot offset bolted tags fuse links

NIT

Catalogue numbers	Rated voltage	Rated current (Amps)	BS Reference	Breaking capacity	Operating class	I ² t (A ² s)		Fixing centre (mm)	Pack quantity	Alternative fuse links	Compatible fuse holders
						Pre-arcing	Total at rated voltage				
NIT2	550 V a.c./ 250 V d.c.	2	A1	80 kA	gG	2.2	15	44	20	NITD	RS20 or CM32FC
NIT4		4	A1	80 kA	gG	7.2	50				
NIT6		6	A1	80 kA	gG	22	150				
NIT10		10	A1	80 kA	gG	170	1000				
NIT16		16	A1	80 kA	gG	200	1350				
NIT20		20	A1	80 kA	gG	360	2200				

Dimensions - mm

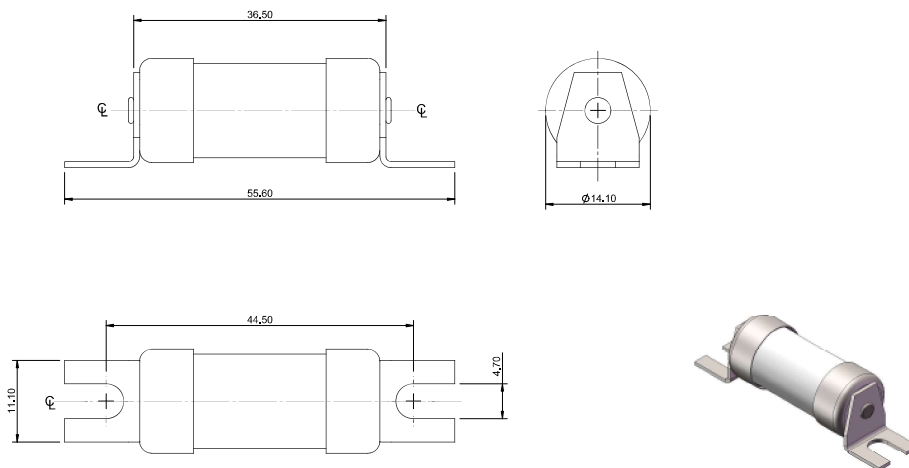

Time current curve

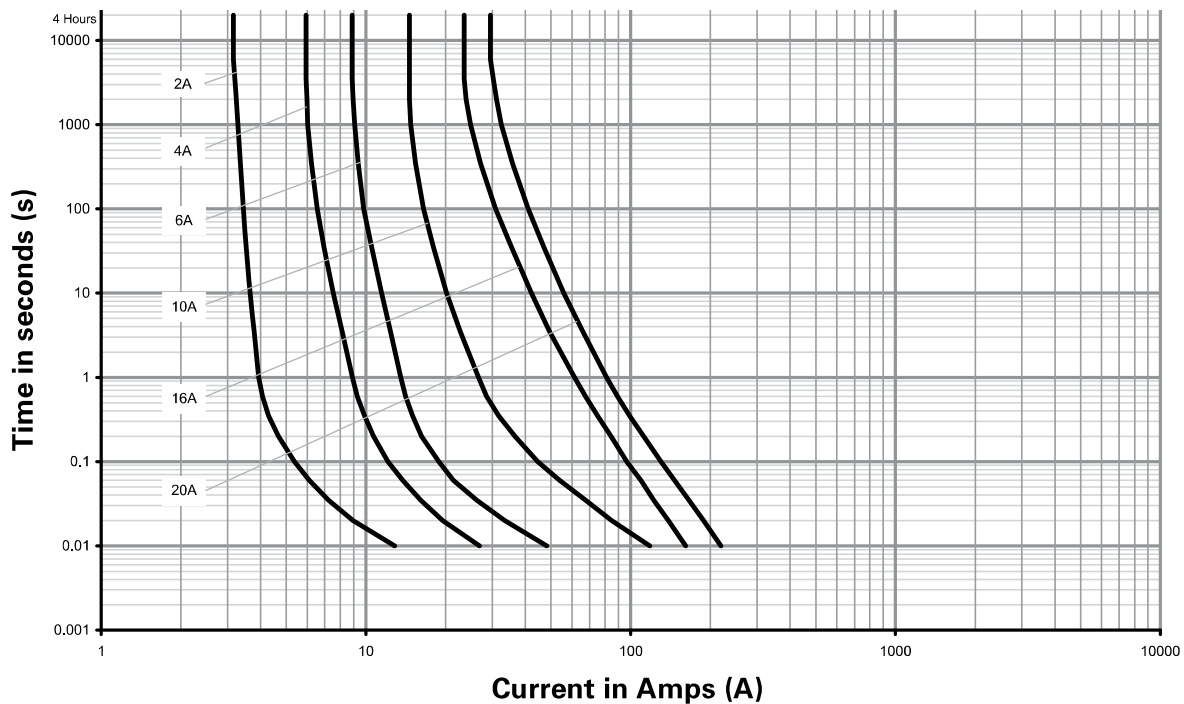

NET

Catalogue numbers	Rated voltage	Rated current (Amps)	BS Reference	Breaking capacity	Operating class	I ^t (A ² s)		Fixing centre (mm)	Pack quantity	Alternative fuse links	Compatible fuse holders
						Pre-arcing	Total at rated voltage				
NET25	440 V a.c./	25	A1	80 kA	gG	650	2900	44	20	NITD	CM32FC
NET32	250 V d.c.	32	A1	80 kA	gG	600	4050				
NET32M40		32M40	A1	80 kA	gM	2400	12,000				
NET32M50		32M50	A1	80 kA	gM	3200	15,000				
NET32M63		32M63	A1	80 kA	gM	5400	25,000				

Dimensions - mm

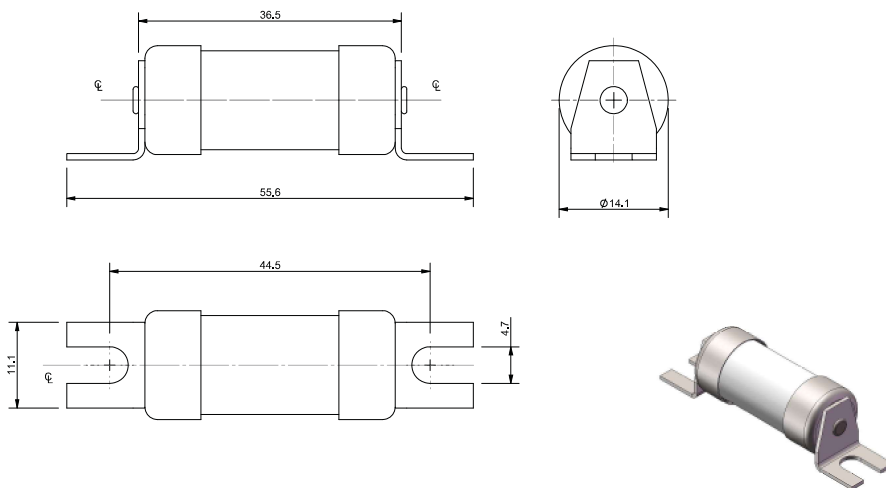

NET25 and NET32

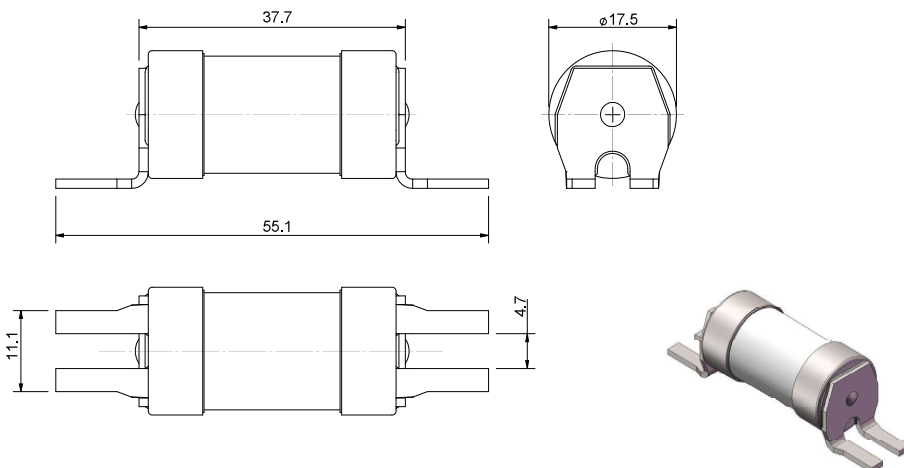

NET32M

Red Spot offset bolted tags fuse links

NET

Time current curve

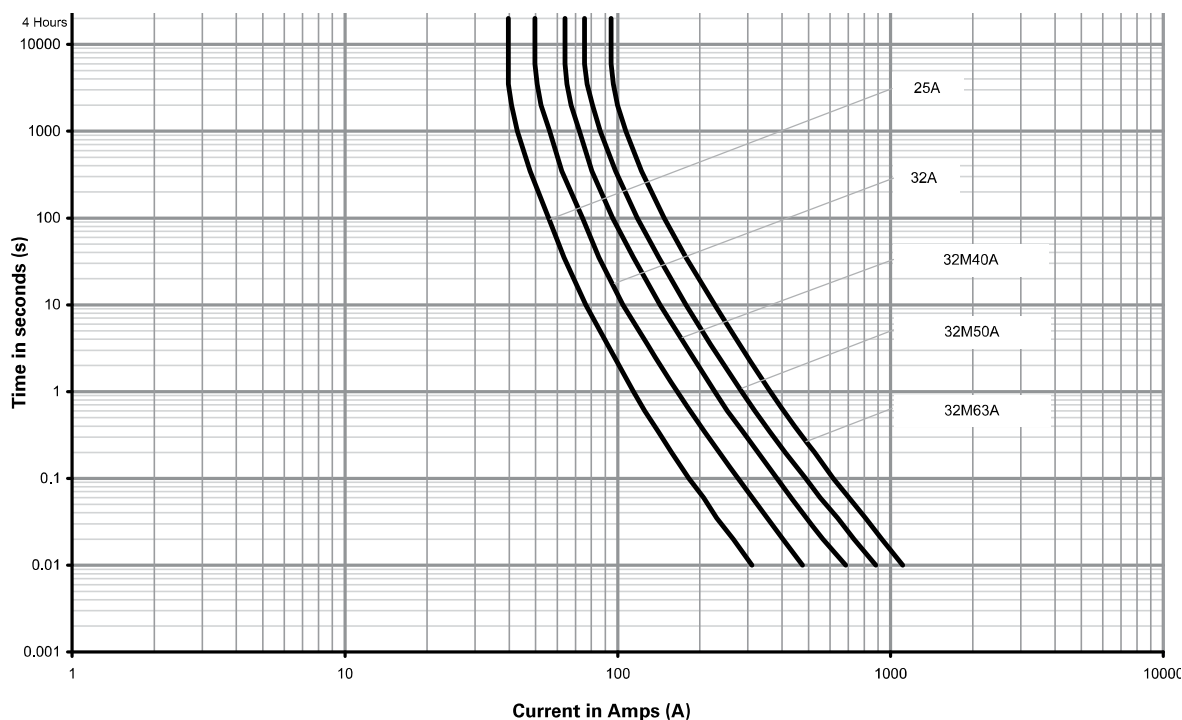

TIA

Catalogue numbers	Rated voltage	Rated current (Amps)	BS Reference	Breaking capacity	Operating class	I ² t (A ² s)		Fixing centre (mm)	Pack quantity	Alternative fuse links	Compatible fuse holders
						Pre-arcing	Total at rated voltage				
TIA2	660-690 V a.c./ 460 V d.c.	2	A2	80 kA	gG	2	15	73	20	H07-660 AAO at 550 V a.c.	CM32F or RS32
TIA4		4	A2	80 kA	gG	7	50				
TIA6		6	A2	80 KA	gG	22	150				
TIA10		10	A2	80 kA	gG	170	1000				
TIA16		16	A2	80 KA	gG	150	1100				
TIA20		20	A2	80 kA	gG	300	1670				
TIA25		25	A2	80 KA	gG	500	3400				
TIA32		32	A2	80 kA	gG	1080	5900				
TIA32M35		32M35	A2	80 KA	gM	1380	6500				
TIA32M40		32M40	A2	80 KA	gM	1920	8380				
TIA32M50		32M50	A2	80 kA	gM	3410	13260				
TIA32M63		32M63	A2	80 KA	gM	6500	25000				

TIA

Dimensions - mm

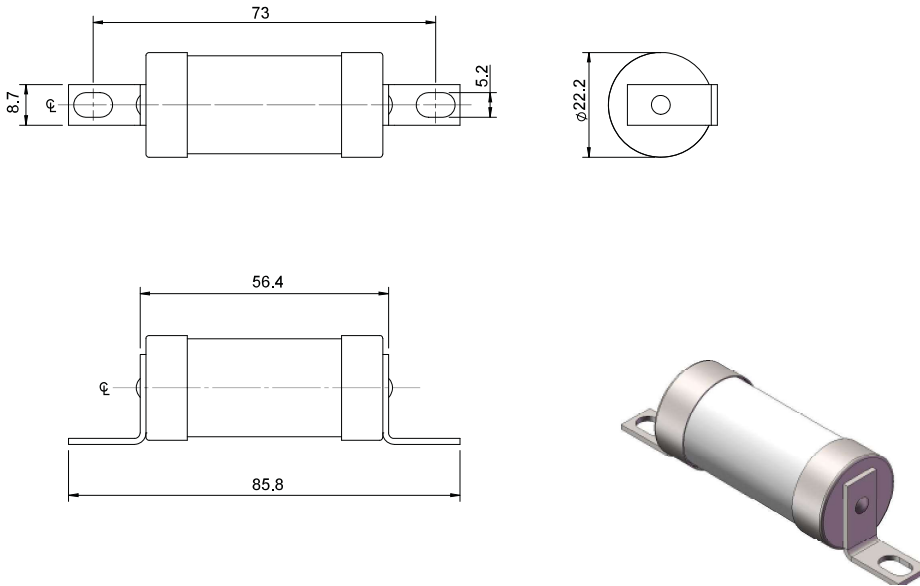

Time current curve

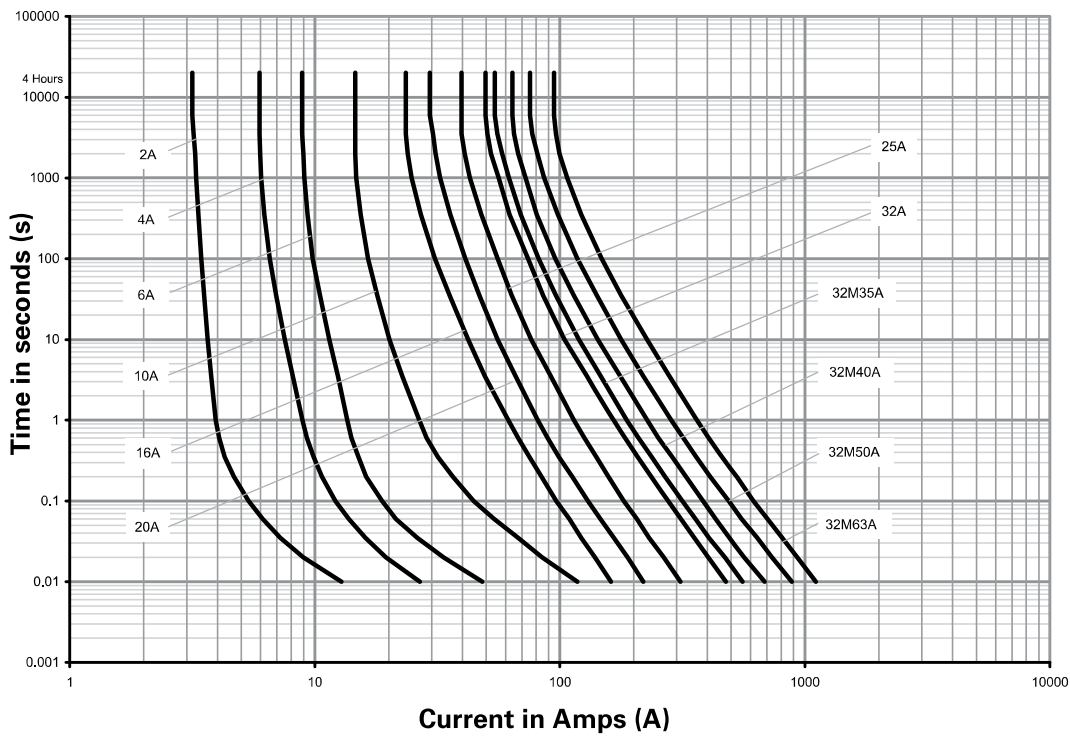

Red Spot offset bolted tags fuse links

TIS

Catalogue numbers	Rated voltage	Rated current (Amps)	BS Reference	Breaking capacity	Operating class	I ² t (A ² s)		Fixing centre (mm)	Pack quantity	Alternative fuse links	Compatible fuse holders
						Pre-arcing	Total at rated voltage				
TIS35	660-690 V a.c./ 460 V d.c.	35	A3	80 kA	gG	1380	6500	73	20	K07-660	RS63H or CM63F
TIS40		40	A3	80 kA	gG	1920	8380				
TIS50		50	A3	80 kA	gG	3410	13260			BA0 at 550 V a.c.	
TIS63		63	A3	80 kA	gG	6500	25000				
TIS63M80		63M80	A3	80 kA	gM	14000	66000				
TIS63M100		63M100	A3	80 kA	gM	17000	100000				

Dimensions - mm

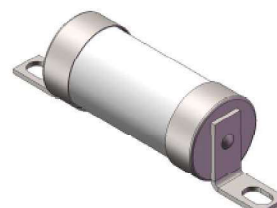
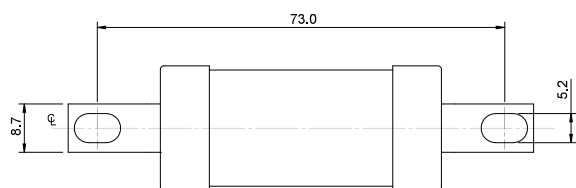
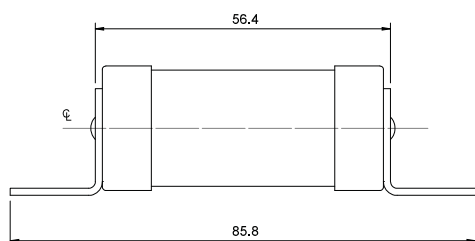

TIS35 to TIS63

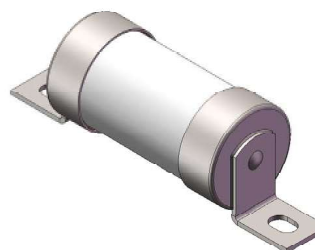
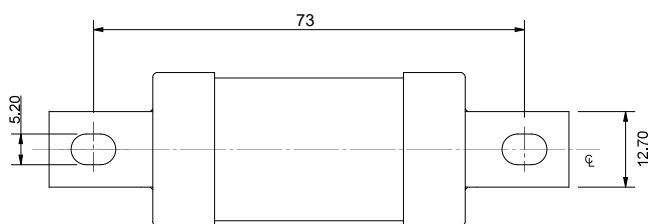
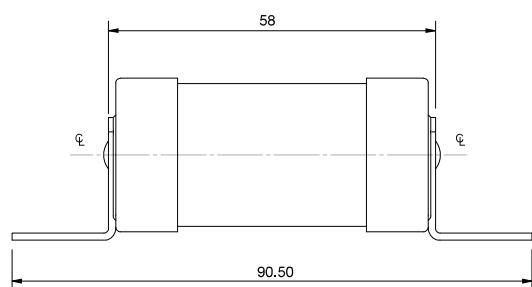

TIS63M80 and TIS63M100

TIS

Time current curve

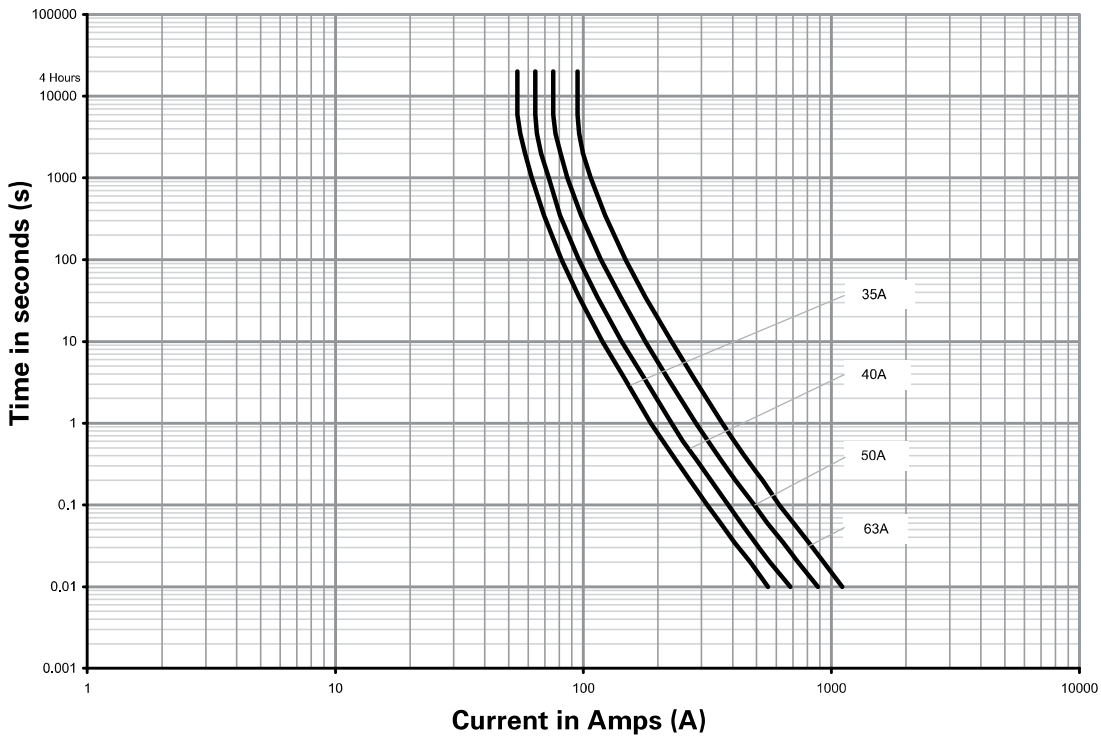

TIS35 to TIS63 A

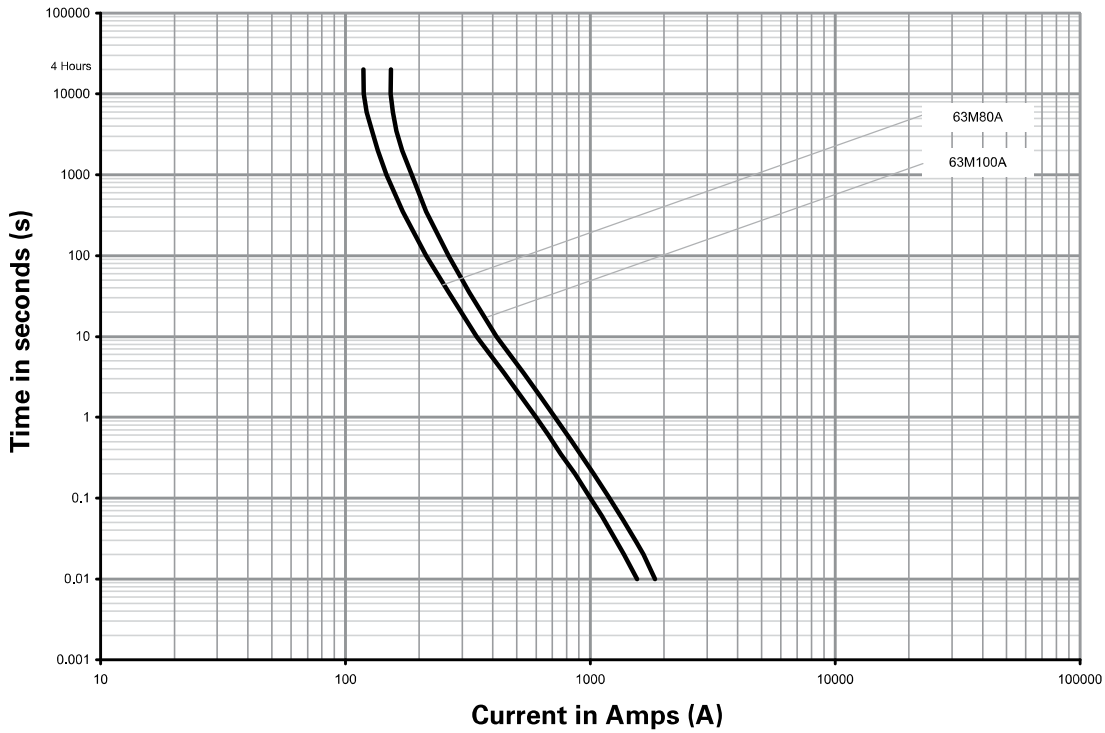

TIS63M80 and TIS63M100

Red Spot offset bolted tags fuse links

TCP

Catalogue numbers	Rated voltage	Rated current (Amps)	BS Reference	Breaking capacity	Operating class	I _t (A ² s)		Fixing centre (mm)	Pack quantity	Alternative fuse links	Compatible fuse holders
						Pre-arcing	Total at rated voltage				
TCP32	660-690 V a.c./ 460 V d.c.	32	A4	80 kA	gG	1080	5900	94	20	L14-660	RS100H
TCP40		40	A4	80 kA	gG	1920	8380				
TCP50		50	A4	80 kA	gG	3410	13260				
TCP63		63	A4	80 kA	gG	6500	25000				
TCP80		80	A4	80 kA	gG	14000	66000				
TCP100	660-690 V a.c.	100	A4	80 kA	gG	17000	100000			CEO at 550 V a.c.	
TCP100M125		100M125	A4	80 kA	gM	25000	140000				
TCP100M160		100M160	A4	80 kA	gM	62000	270000				
TCP100M200		100M200	A4	80 kA	gM	105000	430000				

Dimensions - mm

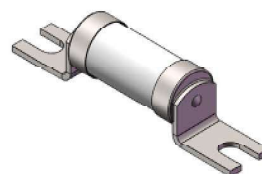
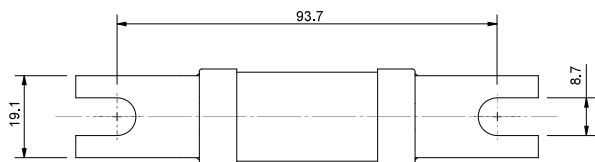
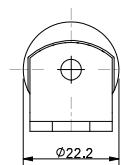
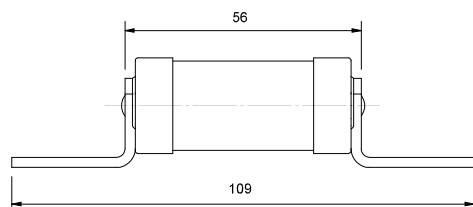

TCP32 to TCP63

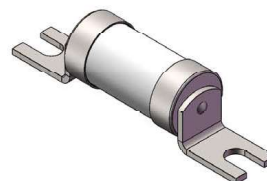
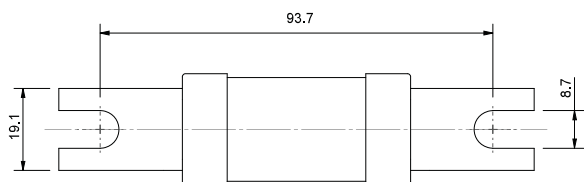
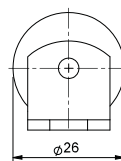
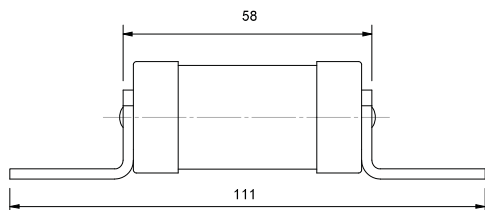

TCP80 and TCP100

TCP

Time current curve

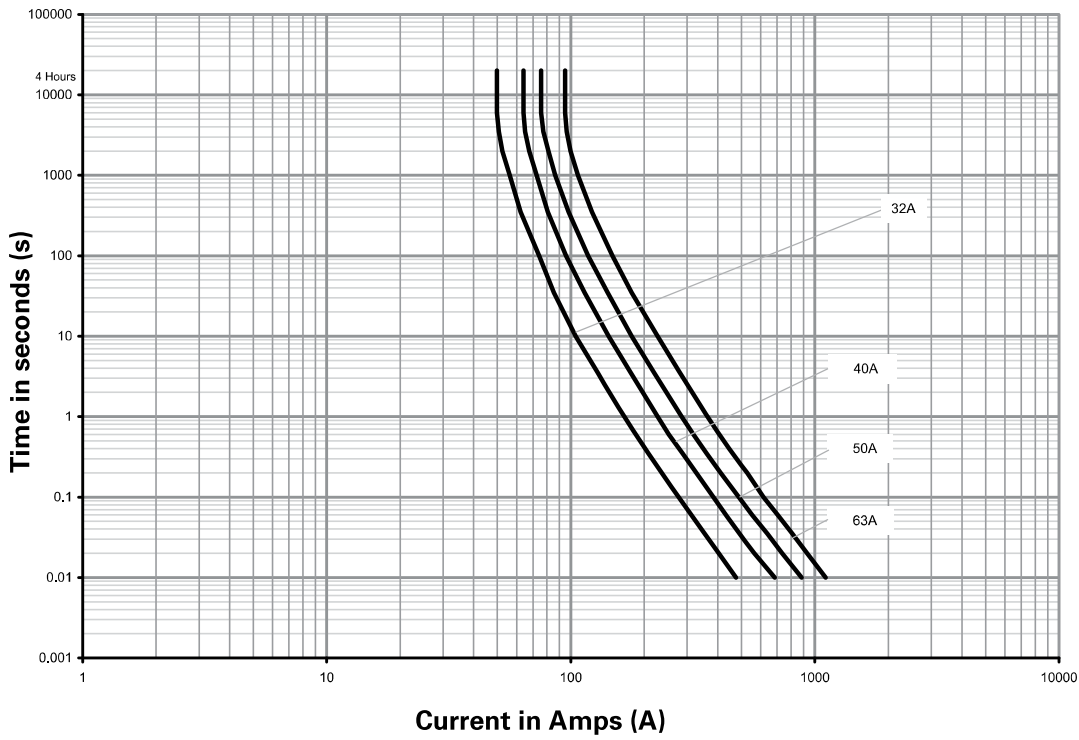

TCP32 to TCP63 A

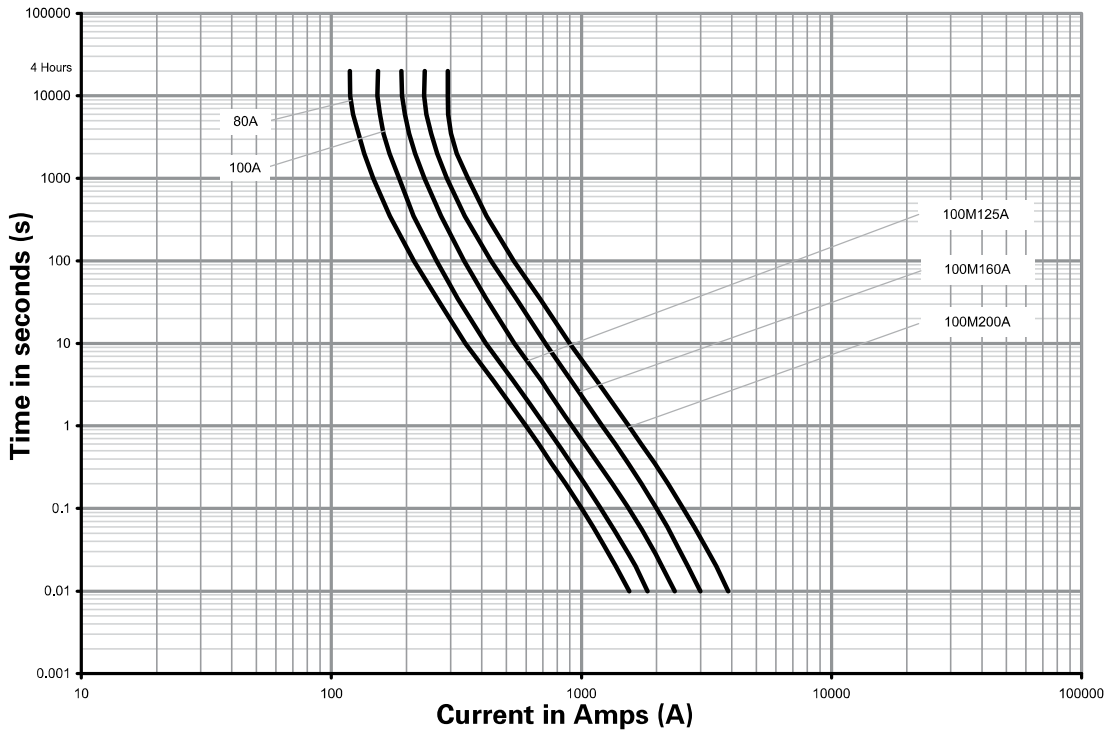

TCP80 to TCP100M200

Red Spot offset bolted tags fuse links

TFP

Catalogue numbers	Rated voltage	Rated current (Amps)	Breaking capacity	Operating class	I ² t (A ² s)		Fixing centre (mm)	Pack quantity	Alternative fuse links
					Pre-arcing	Total at rated voltage			
TFP125	660-690 V a.c./ 350 V d.c.	125	80 kA	gG	25000	140000	94	10	M14-660
TFP160		160	80 kA	gG	62000	270000			
TFP200		200	80 kA	gG	105000	430000			DEO at 550 V a.c.
TFP200M250		200M250	80 kA	gM	200000	870000		1	

* DEO rated at 550 V a.c.

Dimensions - mm

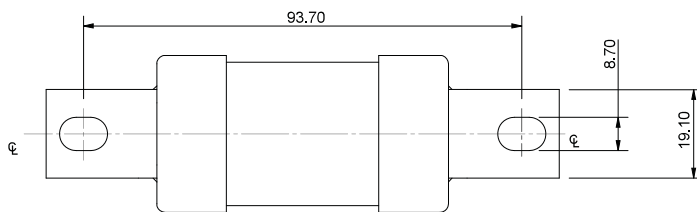
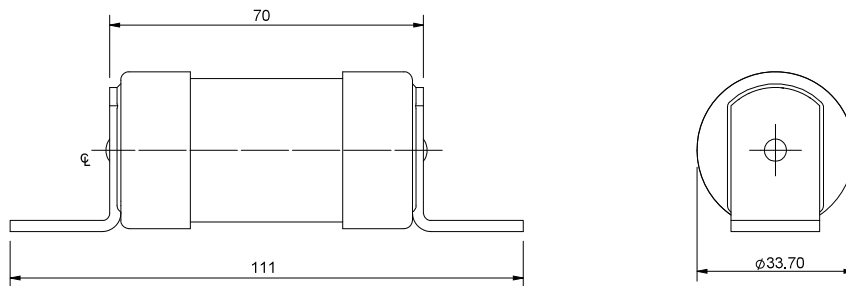

TFP125 to TFP200

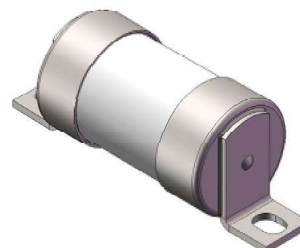
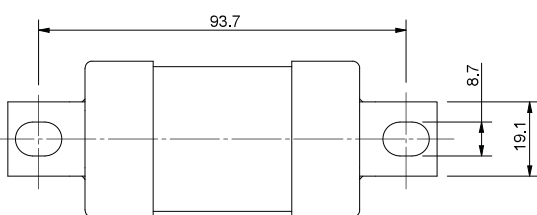
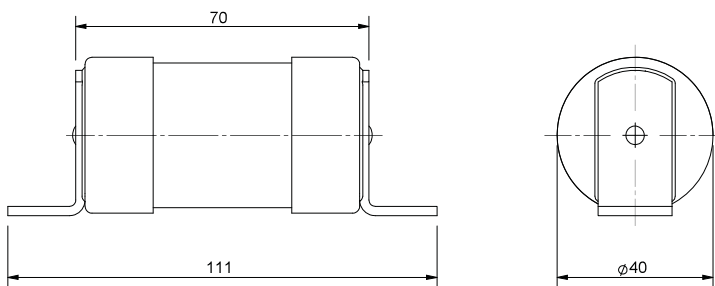

TFP200M250

TFP

Time current curve

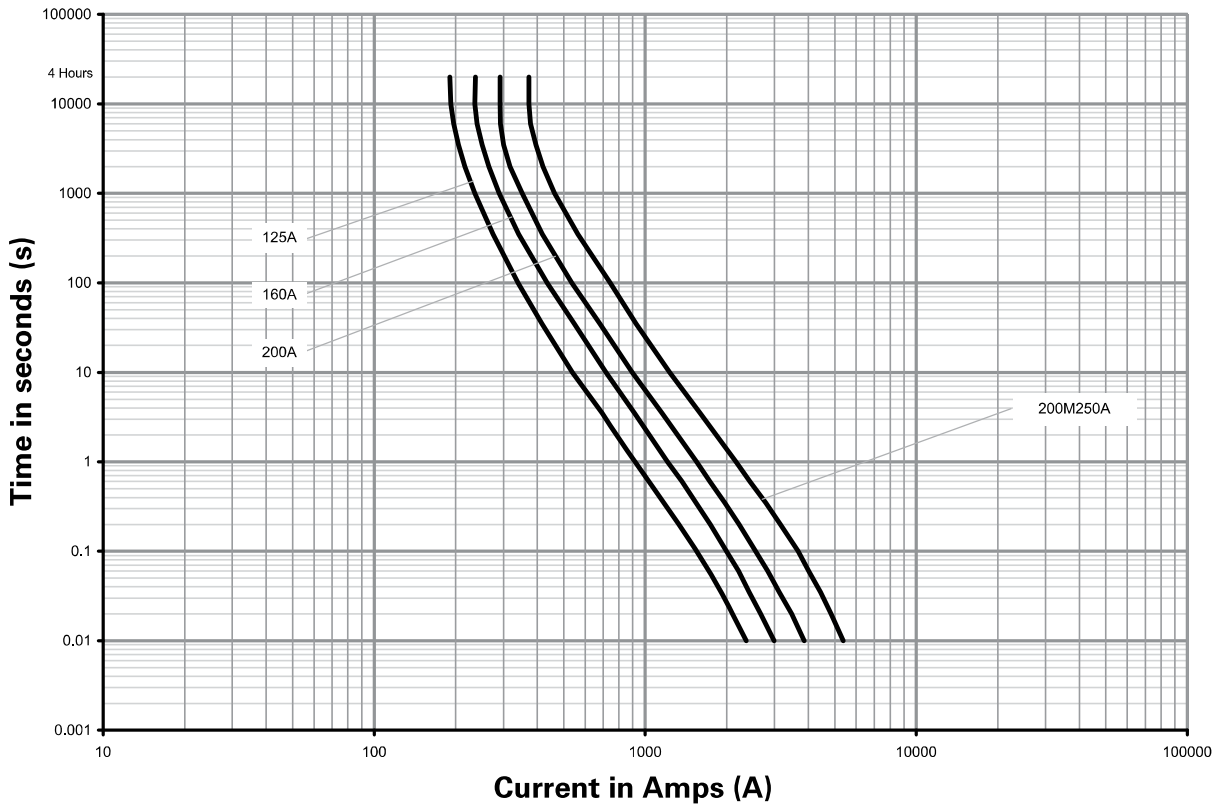

Changes to the products, to the information contained in this document, and to prices are reserved; so are errors and omissions. Only order confirmations and technical documentation by Eaton is binding. Photos and pictures also do not warrant a specific layout or functionality. Their use in whatever form is subject to prior approval by Eaton. The same applies to Trademarks (especially Eaton, Moeller, and Cutler-Hammer). The Terms and Conditions of Eaton apply, as referenced on Eaton Internet pages and Eaton order confirmations.

Eaton
EMEA Headquarters
Route de la Longeraie 7
1110 Morges, Switzerland

Eaton Electrical Products Limited
Unit 1, Hawker Business Park
Melton Road
Burton-on-the-Wolds
Leicestershire, LE12 5TH
United Kingdom

© 2020 Eaton
All Rights Reserved
PDF Only
Publication No. 10020
September 2020