

# ABS 175/125 HG



Sample image

**Order symbol :** ABS 175/125 HG

**Product nr :** 6081322

**Description :** Enclosure, ABS

**Remarks :** High base, grey cover

**EAN :** 6418074052339

**El. number :**

- Finland : 3435224
- Denmark : 8212023725
- Sweden : 6081322

**Including :** Base with TPE gasket. screws for mounting plate/DIN-rail and cover with polyamide cover screws.

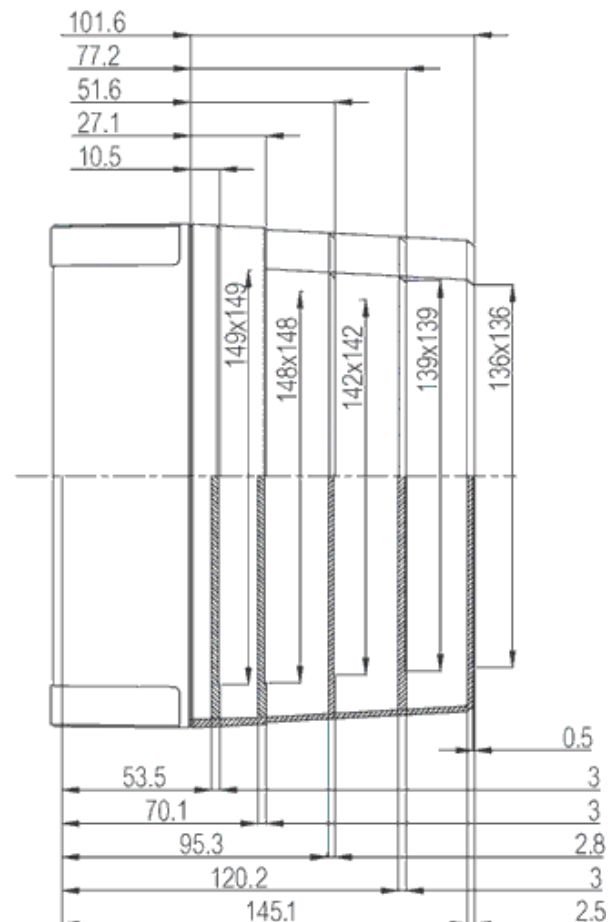
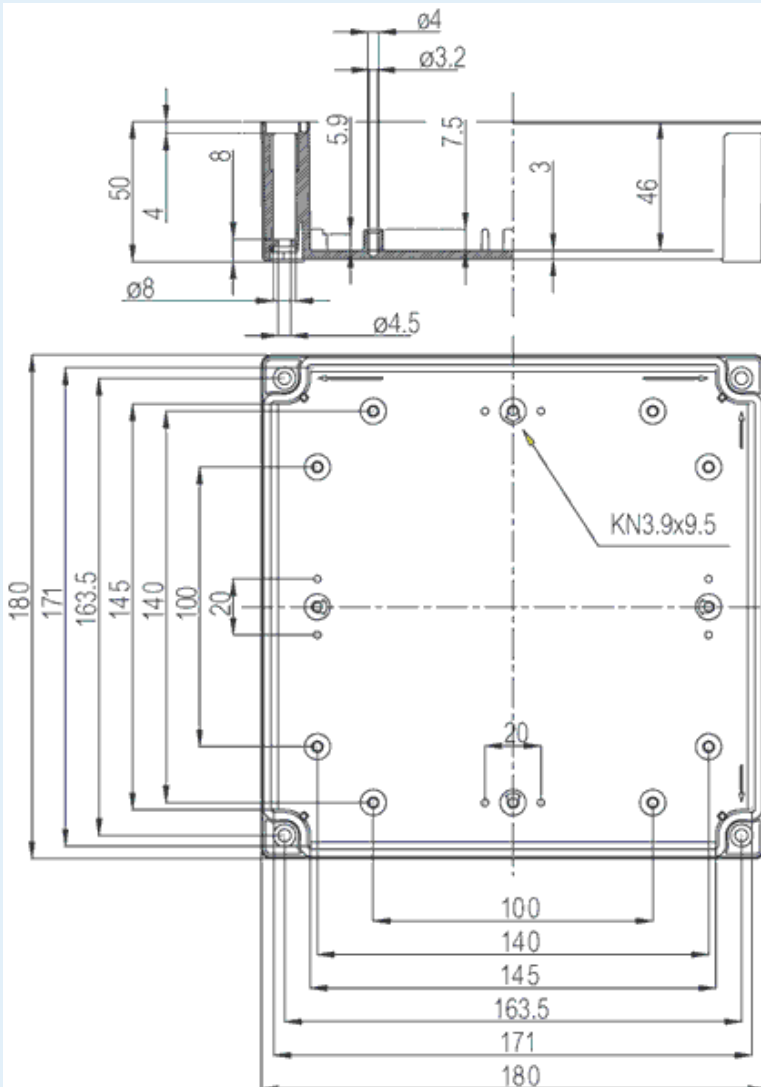

**Dimensions :**

	Height	Width	Depth
mm :	180	180	125
inch :	7.09	7.09	4.92

**Materials :**

Material :	ABS
Base colour :	RAL_7035
Cover colour :	RAL 7035 -light grey
Gasket material :	Polyurethane

**Temperatures :**

Temperature °C (continuous) :	-40 ... 60
Temperature °F (continuous) :	-40 ... 140

**Accessories :**

MIV 175	Mounting plate (Galvanized steel), for enclosures: (148 x 148 x 1)
FP A 175/180	Front plate (Aluminium), for enclosures: (170 x 162 x 1)
HFP 180	Front plate hinge series
MIN 15	DIN-15 Mounting rail, for enclosures: (150 x 15 x 1)
MIV 15	DIN-35 Mounting rail, for enclosures: (150 x 35 x 7)
FP 22046	Wall fastening lug (4 pcs)

**Ratings :**

Ingress protection (EN 60529):	IP66; IP67;
Impact Resistance (EN 62262):	IK07;
electrical_insulation :	Totally insulated
Halogen free (DIN/VDE 0472, Part 815) :	Yes
UV resistance :	-
Flammability Rating :	UL 94 HB
Glow Wire Test (IEC 695-2-1) °C :	650C

**Certificates :**

Certificate FI 41115