

# ABS B 65 G



Sample image

**Order symbol :** ABS B 65 G

**Product nr :** 8784303

**Description :** Enclosure, ABS

**Remarks :** Grey cover

**EAN :** 6418074001993

**El. number :**

- Finland : 3423451
- Denmark : 8212001802
- Sweden : 2536701

**Including :** Base with screws for mounting plate/DIN-rail. cover with PUR gasket and polyamide cover screws.

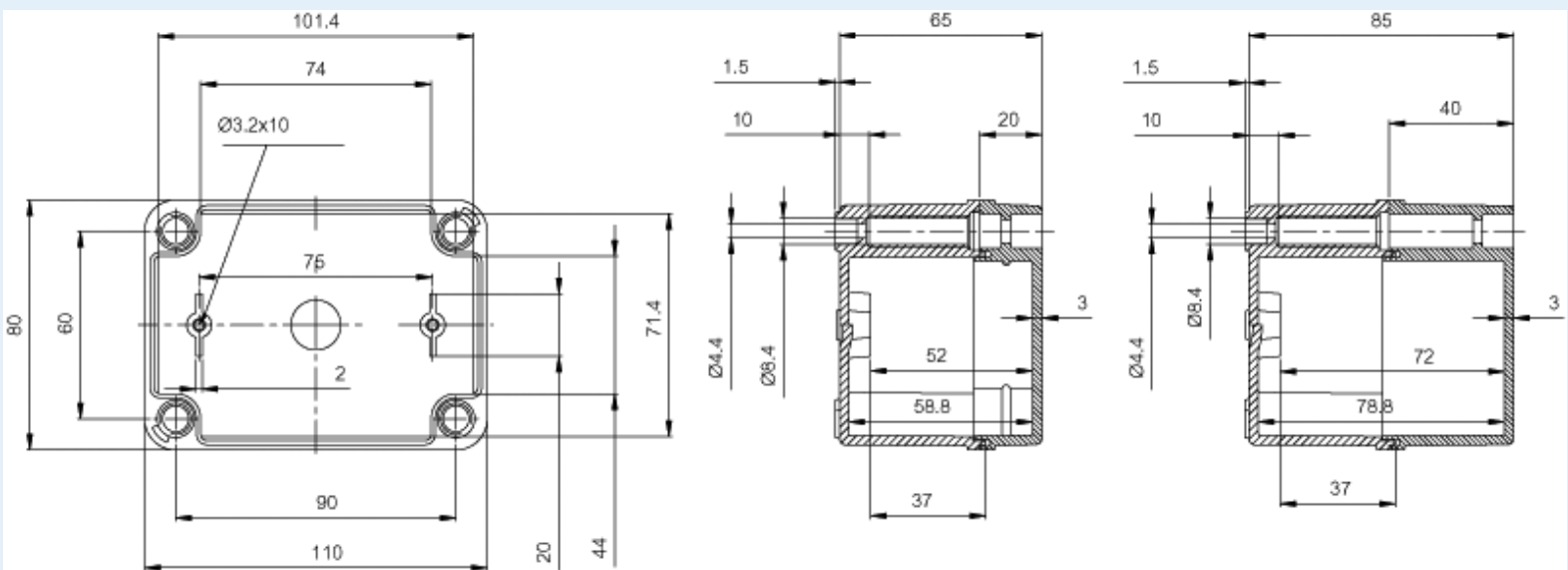

Dimensions :	Height	Width	Depth
mm :	110	80	65
inch :	4.33	3.15	2.56

## Materials :

Material :	ABS
Base colour :	RAL 7035 -light grey
Cover colour :	RAL 7035 -light grey
Gasket material :	Polyurethane

## Accessories :

B-MP	Mounting plate, for enclosures: (80 x 54 x 1)
FP 22040	Wall fastening lug (2 pcs), for enclosures:
B-3	DIN-35 Mounting rail, for enclosures: (80 x 35 x 7)

## Ratings :

Ingress protection (EN 60529):	IP66; IP67;
Impact Resistance (EN 62262):	IK08;
electrical_insulation :	Totally insulated

**Temperatures :**

Temperature °C (short term) :	-40 ... 80
Temperature °F (short term) :	-40 ... 175
Temperature °F (continuous) :	-40 ... 140

Halogen free (DIN/VDE 0472, Part 815) :	Yes
UV resistance :	-
Flammability Rating :	UL 94 HB
Glow Wire Test (IEC 695-2-1) °C :	650C

**Certificates :**

SGSFIMKO\_PICC\_pc