

## Data Sheet | Item Number: 2002-1811/1000-541

4-conductor fuse terminal block; with pivoting fuse holder; with end plate; for 5 x 20 mm miniature metric fuse; with blown fuse indication by LED; 12 - 30 V; for DIN-rail 35 x 15 and 35 x 7.5; 2.5 mm<sup>2</sup>; Push-in CAGE CLAMP®; 2,50 mm<sup>2</sup>; gray

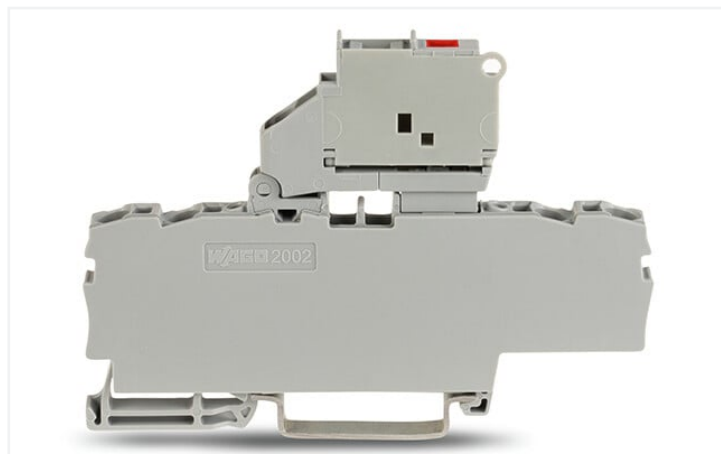

<https://www.wago.com/2002-1811/1000-541>

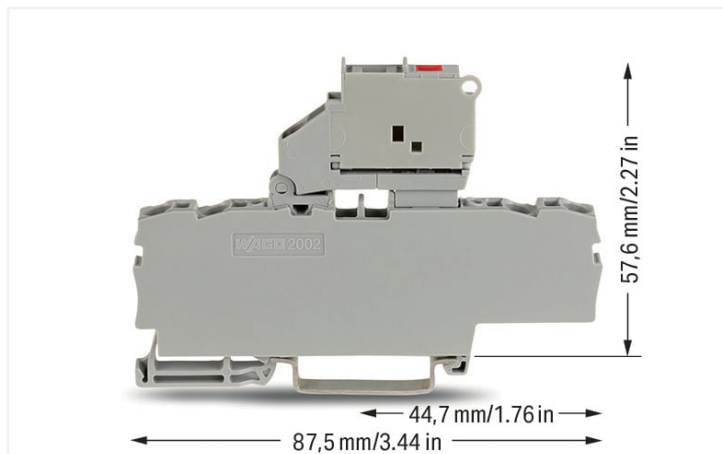

Color: ■ gray

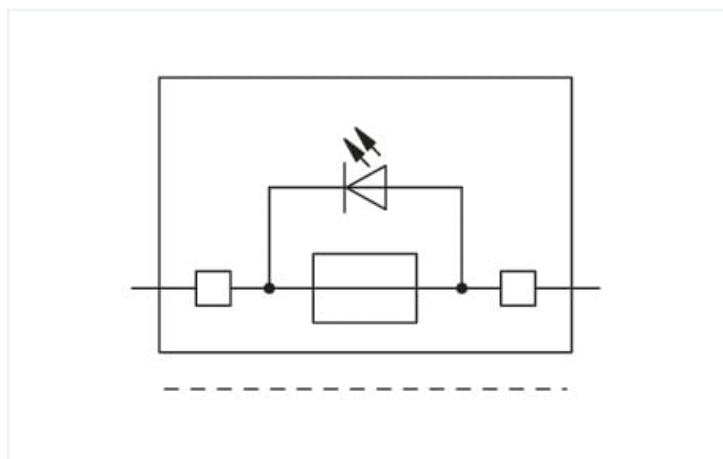

### Electrical data

Ratings per	IEC/EN 60947-7-3		
Overvoltage category	III	III	II
Pollution degree	3	2	2
Nominal voltage	250 V	-	-
Rated surge voltage	6 kV	-	-
Rated current	6.3 A	-	-

### Ratings per IEC/EN – Notes

Ratings (note)	Electrical ratings are given by the fuse and blown fuse indication.
Note (rated current)	Leakage current in case of a blown fuse: LED 2.2 mA (at 24 V operating voltage)

Ratings per	IEC/EN 60947-7-3		
Overvoltage category	III	III	II
Pollution degree	3	2	2
Nominal voltage	30 V	-	-
Rated surge voltage	0.8 kV	-	-
Rated current	-	-	-

Approvals per	UL 1059		
Use group	B	C	D
Rated voltage	30 V	30 V	30 V
Rated current	10 A	10 A	10 A

Approvals per	CSA 22.2 No 158		
Use group	B	C	D
Rated voltage	250 V	250 V	-
Rated current	6.3 A	6.3 A	-

Power Loss	
Power loss (max.) $P_{I(max)}$ (note)	When selecting glass cartridge fuses, make sure that the maximum power loss listed below is not exceeded. The power loss is determined according to IEC or EN 60947-7-3/VDE 0611-6 at 23°C. The temperature rise of the terminal block must be checked according to their application and mounting. Higher ambient temperatures represent an additional impact on miniature fuses. Therefore, in such applications, the rated current must be reduced if necessary. More details are available from the manufacturers.
Power loss $P_I$ max. overload and short-circuit protection (individual arrangement)	1.6 W
Power loss $P_I$ max. overload and short-circuit protection (group arrangement)	1.6 W
Power loss $P_I$ max. short-circuit protection (individual arrangement)	2.5 W
Power loss $P_I$ max. short-circuit protection (group arrangement)	2.5 W

Connection data	
Connection points	4
Total number of potentials	1
Number of levels	1
Number of jumper slots	2

Ex information	
Reference hazardous areas	See "Downloads – Documentation – Additional Information: Technical Section; Technical Explications"
Ratings per	ATEX: KIWA 17 ATEX 0030 U / IECEx: KIWA 17.0014U (Ex ec IIC Gc)
Rated voltage EN (Ex e II)	24 V
Rated current (Ex e II)	6.3 A

General information	
Fuse receptacle	pivoting
Fuse type	Cylindrical fuse; 5 x 20 mm

Connection 1	
Connection technology	Push-in CAGE CLAMP®
Actuation type	Operating tool
Connectable conductor materials	Copper
Nominal cross-section	2.5 mm <sup>2</sup>
Solid conductor	0.25 ... 4 mm <sup>2</sup> / 22 ... 12 AWG
Solid conductor; push-in termination	0.75 ... 4 mm <sup>2</sup> / 18 ... 12 AWG
Fine-stranded conductor	0.25 ... 4 mm <sup>2</sup> / 22 ... 12 AWG
Fine-stranded conductor; with insulated ferrule	0.25 ... 2.5 mm <sup>2</sup> / 22 ... 14 AWG
Fine-stranded conductor; with ferrule; push-in termination	1 ... 2.5 mm <sup>2</sup> / 18 ... 14 AWG
Note (conductor cross-section)	Depending on the conductor characteristic, a conductor with a smaller cross-section can also be inserted via push-in termination.
Strip length	10 ... 12 mm / 0.39 ... 0.47 inches
Wiring direction	Front-entry wiring

### Physical data

Width	6.2 mm / 0.244 inches
Height	87.5 mm / 3.445 inches
Depth from upper-edge of DIN-rail	57.6 mm / 2.268 inches

### Mechanical data

Mounting type	DIN-35 rail
Marking level	Center/side marking

### Material data

Note (material data)	<a href="#">Information on material specifications can be found here</a>
Color	gray
Material group	I
Insulation material	Polyamide (PA66)
Flammability class per UL94	V0
Fire load	0.352 MJ
Weight	16.4 g

### Environmental requirements

Ambient temperature (operation)	-35 ... +70 °C
Processing temperature	-35 ... +70 °C
Continuous operating temperature	-35 ... +70 °C

### Commercial data

Product Group	22 (TOPJOB S)
eCl@ss 10.0	27-14-11-16
eCl@ss 9.0	27-14-11-16
ETIM 8.0	EC000899
ETIM 7.0	EC000899
PU (SPU)	50 pcs
Packaging type	Box
Country of origin	CN
GTIN	4066966335811
Customs tariff number	85369095000

### Environmental Product Compliance

CAS-No.	7439-92-1
REACH Candidate List Substance	Lead
RoHS Compliance Status	Compliant,With Exemption
RoHS Exemption	6(c) 7(a) 7(c)-I 7(c)-II
SCIP notification number (Austria)	d0b30d52-73d3-4a2a-a411-48f0be3ee0e4
SCIP notification number (Belgium)	813c9825-02f2-4924-a88c-4748fea40a85
SCIP notification number (Bulgaria)	eb314a5a-9b9d-4b08-b7f3-8722968e7b39
SCIP notification number (Czech Republic)	ee713557-b66f-45d8-a6fe-f7980a062275
SCIP notification number (Denmark)	dd7e8b88-3a87-4f7a-85f3-fb69ea3b72c1
SCIP notification number (Finland)	f9d5db8b-1373-4249-bb38-ec2705911021
SCIP notification number (France)	061286d0-e9b9-45fd-b8f4-23830ea0aab9
SCIP notification number (Germany)	ae03cb31-d922-426e-8e39-0d15285820be
SCIP notification number (Hungary)	59bb5d50-aa15-43ae-8743-b030b65e7d57
SCIP notification number (Italy)	00c1a702-920b-40d8-b02a-fb863e652135

**Environmental Product Compliance**

SCIP notification number (Netherlands)	ed2a5c75-86f2-4bca-a166-1fdc9fdb74b1
SCIP notification number (Poland)	ecbda195-814e-4317-bdad-d3839b32fa84
SCIP notification number (Romania)	5cba95f8-a425-4c6c-81c2-91cdd82d7ebb
SCIP notification number (Sweden)	b8a321a4-49d6-46ff-a8f3-e9fce4b5d820

**Approvals / Certificates**

**General approvals** **Declarations of conformity and manufacturer's declarations**



Approval	Standard	Certificate Name
CCA DEKRA Certification B.V.	EN 60947	NTR NL 7941
KEMA/KEUR DEKRA Certification B.V.	EN 60947	71-124163
UL Underwriters Laboratories Inc.	UL 1059	E45172



Approval	Standard	Certificate Name
ATEX-Attestation of Conformity WAGO GmbH & Co. KG	-	-
ATEX-Attestation of Conformity WAGO GmbH & Co. KG	-	-
EU-Declaration of Conformity WAGO GmbH & Co. KG	-	-
Railway WAGO GmbH & Co. KG	-	Railway Ready
UK-Declaration of Conformity WAGO GmbH & Co. KG	-	-

**Approvals for marine applications**



Approval	Standard	Certificate Name
ABS American Bureau of Shipping	EN 60947	20-HG1941090-PDA
DNV GL Det Norske Veritas, Germanischer Lloyd	-	TAE00001V2

**Approvals for hazardous areas**



Approval	Standard	Certificate Name
AEx Underwriters Laboratories Inc.	UL 60079	E185892 (AEx eb IIC resp. Ex eb IIC)
ATEX KIWA Netherlands B.V.	EN 60079	KIWA 17ATEX0030 U
CCC CNEX	GB/T 3836.3	2020312313000180 (Ex ec IIC Gc)
IECEx KIWA Netherlands B.V.	EN 60079	IECEx KIWA 17.0014U (Ex ec IIC Gc)

**Downloads**

**Environmental Product Compliance**

Compliance Search
Environmental Product Compliance 2002-1811/1000-541



## Documentation

Bid Text			
2002-1811/1000-541	24.04.2019	xml 4.29 KB	
2002-1811/1000-541	23.04.2019	docx 15.67 KB	

## CAD/CAE-Data

CAD data	
2D/3D Models 2002-1811/1000-541	

CAE data	
EPLAN Data Portal 2002-1811/1000-541	
WSCAD Universe 2002-1811/1000-541	
ZUKEN Portal 2002-1811/1000-541	

## 1 Compatible Products

### 1.1 Required Accessories

#### 1.1.1 End plate

##### 1.1.1.1 End plate



**Item No.: 209-191**

Separator for Ex e/Ex i applications; 3 mm thick; 120 mm wide; orange

### 1.2 Optional Accessories

#### 1.2.1 DIN-rail

##### 1.2.1.1 Mounting accessories



**Item No.: 210-196**

Aluminum carrier rail; 35 x 8.2 mm; 1.6 mm thick; 2 m long; unslotted; similar to EN 60715; silver-colored



**Item No.: 210-198**

Copper carrier rail; 35 x 15 mm; 2.3 mm thick; 2 m long; unslotted; according to EN 60715; copper-colored



**Item No.: 210-508**

Steel carrier rail; 35 x 15 mm; 1.5 mm thick; 2 m long; slotted; galvanized; similar to EN 60715; silver-colored



**Item No.: 210-197**

Steel carrier rail; 35 x 15 mm; 1.5 mm thick; 2 m long; slotted; similar to EN 60715; silver-colored



**Item No.: 210-506**

Steel carrier rail; 35 x 15 mm; 1.5 mm thick; 2 m long; unslotted; galvanized; similar to EN 60715; silver-colored



**Item No.: 210-114**

Steel carrier rail; 35 x 15 mm; 1.5 mm thick; 2 m long; unslotted; similar to EN 60715; silver-colored



**Item No.: 210-118**

Steel carrier rail; 35 x 15 mm; 2.3 mm thick; 2 m long; unslotted; according to EN 60715; silver-colored



**Item No.: 210-115**

Steel carrier rail; 35 x 7.5 mm; 1 mm thick; 2 m long; slotted; according to EN 60715; "Hole width 18 mm; silver-colored



**Item No.: 210-112**

Steel carrier rail; 35 x 7.5 mm; 1 mm thick; 2 m long; slotted; according to EN 60715; "Hole width 25 mm; silver-colored



**Item No.: 210-504**

Steel carrier rail; 35 x 7.5 mm; 1 mm thick; 2 m long; slotted; galvanized; according to EN 60715; silver-colored



**Item No.: 210-113**

Steel carrier rail; 35 x 7.5 mm; 1 mm thick; 2 m long; unslotted; according to EN 60715; silver-colored



**Item No.: 210-505**

Steel carrier rail; 35 x 7.5 mm; 1 mm thick; 2 m long; unslotted; galvanized; according to EN 60715; silver-colored

## 1.2.2 End plate

### 1.2.2.1 End plate



**Item No.: 2002-991**

End plate for fuse terminal blocks; 2 mm thick; gray



**Item No.: 2002-992**

End plate for fuse terminal blocks; 2 mm thick; orange

## 1.2.3 Ferrule

### 1.2.3.1 Ferrule



**Item No.: 216-241**

Ferrule; Sleeve for 0.5 mm<sup>2</sup> / 20 AWG; insulated; electro-tin plated; electrolytic copper; gastight crimped; acc. to DIN 46228, Part 4/09.90; white



**Item No.: 216-242**

Ferrule; Sleeve for 0.75 mm<sup>2</sup> / 18 AWG; insulated; electro-tin plated; electrolytic copper; gastight crimped; acc. to DIN 46228, Part 4/09.90; gray



**Item No.: 216-262**

Ferrule; Sleeve for 0.75 mm<sup>2</sup> / 18 AWG; insulated; electro-tin plated; electrolytic copper; gastight crimped; acc. to DIN 46228, Part 4/09.90; gray



**Item No.: 216-243**

Ferrule; Sleeve for 1 mm<sup>2</sup> / AWG 18; insulated; electro-tin plated; electrolytic copper; gastight crimped; acc. to DIN 46228, Part 4/09.90; red



**Item No.: 216-263**

Ferrule; Sleeve for 1 mm<sup>2</sup> / AWG 18; insulated; electro-tin plated; electrolytic copper; gastight crimped; acc. to DIN 46228, Part 4/09.90; red



**Item No.: 216-244**

Ferrule; Sleeve for 1.5 mm<sup>2</sup> / AWG 16; insulated; electro-tin plated; electrolytic copper; gastight crimped; acc. to DIN 46228, Part 4/09.90; black



**Item No.: 216-264**

Ferrule; Sleeve for 1.5 mm<sup>2</sup> / AWG 16; insulated; electro-tin plated; electrolytic copper; gastight crimped; acc. to DIN 46228, Part 4/09.90; black



**Item No.: 216-246**

Ferrule; Sleeve for 2.5 mm<sup>2</sup> / AWG 14; insulated; electro-tin plated; electrolytic copper; gastight crimped; acc. to DIN 46228, Part 4/09.90; blue



**Item No.: 216-266**

Ferrule; Sleeve for 2.5 mm<sup>2</sup> / AWG 14; insulated; electro-tin plated; electrolytic copper; gastight crimped; acc. to DIN 46228, Part 4/09.90; blue

## 1.2.4 Installation

### 1.2.4.1 Cover



**Item No.: 709-156**

Cover; Type 3; suitable for cover carrier, type 3; 1 m long; transparent

### 1.2.4.2 Cover carrier



**Item No.: 709-169**

Cover carrier; Type 3; incl. fixing/retaining screws and knurled nut; suitable for 279 to 282 and 880 Series rail-mounted terminal blocks; suitable for 264 Series miniature rail-mounted terminal blocks; suitable for 270 Series sensor and actuator terminal blocks; gray

## 1.2.5 Insulation stop

### 1.2.5.1 Insulation stop



**Item No.: 2002-171**

Insulation stop; 0.25 - 0.5 mm²; 5 pieces/strip; light gray



**Item No.: 2002-172**

Insulation stop; 0.75 - 1 mm²; 5 pieces/strip; dark gray

## 1.2.6 Jumper

### 1.2.6.1 Jumper



**Item No.: 2004-406/020-000**

Delta jumper; insulated; light gray



**Item No.: 2004-410**

Jumper; 10-way; insulated; light gray



**Item No.: 2004-402**

Jumper; 2-way; insulated; light gray



**Item No.: 2004-403**

Jumper; 3-way; insulated; light gray



**Item No.: 2004-404**

Jumper; 4-way; insulated; light gray



**Item No.: 2004-405**

Jumper; 5-way; insulated; light gray



**Item No.: 2004-406**

Jumper; 6-way; insulated; light gray



**Item No.: 2004-407**

Jumper; 7-way; insulated; light gray



**Item No.: 2004-408**

Jumper; 8-way; insulated; light gray



**Item No.: 2004-409**

Jumper; 9-way; insulated; light gray



**Item No.: 2004-440**

Jumper; from 1 to 10; insulated; light gray



**Item No.: 2004-433**

Jumper; from 1 to 3; insulated; light gray



**Item No.: 2004-434**

Jumper; from 1 to 4; insulated; light gray



**Item No.: 2004-435**

Jumper; from 1 to 5; insulated; light gray



**Item No.: 2004-436**

Jumper; from 1 to 6; insulated; light gray



**Item No.: 2004-437**

Jumper; from 1 to 7; insulated; light gray



**Item No.: 2004-438**

Jumper; from 1 to 8; insulated; light gray



**Item No.: 2004-439**

Jumper; from 1 to 9; insulated; light gray



**Item No.: 2004-405/011-000**

Star point jumper; 3-way; insulated; light gray



**Item No.: 210-103**

Wire commoning chain; insulated; black



**Item No.: 210-123**

Wire commoning chain; insulated; blue

## 1.2.7 Locking system

### 1.2.7.1 Locking system







































**Item No.: 210-254**

Interlocking link; mechanically locks multiple links; 1 m long; transparent

1.2.8 Marking

1.2.8.1 Marker

<p><b>Item No.: 2009-145/000-006</b> Mini-WSB Inline; for Smart Printer; 1700 pieces on roll; stretchable 5 - 5.2 mm; plain; snap-on type; blue</p> 	<p><b>Item No.: 2009-145/000-007</b> Mini-WSB Inline; for Smart Printer; 1700 pieces on roll; stretchable 5 - 5.2 mm; plain; snap-on type; gray</p> 	<p><b>Item No.: 2009-145/000-023</b> Mini-WSB Inline; for Smart Printer; 1700 pieces on roll; stretchable 5 - 5.2 mm; plain; snap-on type; green</p> 	<p><b>Item No.: 2009-145/000-012</b> Mini-WSB Inline; for Smart Printer; 1700 pieces on roll; stretchable 5 - 5.2 mm; plain; snap-on type; orange</p> 
<p><b>Item No.: 2009-145/000-005</b> Mini-WSB Inline; for Smart Printer; 1700 pieces on roll; stretchable 5 - 5.2 mm; plain; snap-on type; red</p> 	<p><b>Item No.: 2009-145/000-024</b> Mini-WSB Inline; for Smart Printer; 1700 pieces on roll; stretchable 5 - 5.2 mm; plain; snap-on type; violet</p> 	<p><b>Item No.: 2009-145</b> Mini-WSB Inline; for Smart Printer; 1700 pieces on roll; stretchable 5 - 5.2 mm; plain; snap-on type; white</p> 	<p><b>Item No.: 2009-145/000-002</b> Mini-WSB Inline; for Smart Printer; 1700 pieces on roll; stretchable 5 - 5.2 mm; plain; snap-on type; yellow</p> 
<p><b>Item No.: 248-501/000-006</b> Mini-WSB marking card; as card; not stretchable; plain; snap-on type; blue</p> 	<p><b>Item No.: 248-501/000-007</b> Mini-WSB marking card; as card; not stretchable; plain; snap-on type; gray</p> 	<p><b>Item No.: 248-501/000-023</b> Mini-WSB marking card; as card; not stretchable; plain; snap-on type; green</p> 	<p><b>Item No.: 248-501/000-017</b> Mini-WSB marking card; as card; not stretchable; plain; snap-on type; light green</p> 
<p><b>Item No.: 248-501/000-012</b> Mini-WSB marking card; as card; not stretchable; plain; snap-on type; orange</p> 	<p><b>Item No.: 248-501/000-005</b> Mini-WSB marking card; as card; not stretchable; plain; snap-on type; red</p> 	<p><b>Item No.: 248-501/000-024</b> Mini-WSB marking card; as card; not stretchable; plain; snap-on type; violet</p> 	<p><b>Item No.: 248-501</b> Mini-WSB marking card; as card; not stretchable; plain; snap-on type; white</p> 
<p><b>Item No.: 248-501/000-002</b> Mini-WSB marking card; as card; not stretchable; plain; snap-on type; yellow</p> 	<p><b>Item No.: 793-5501/000-006</b> WMB marking card; as card; for terminal block width 5 - 17.5 mm; stretchable 5 - 5.2 mm; plain; snap-on type; blue</p> 	<p><b>Item No.: 793-5501/000-014</b> WMB marking card; as card; for terminal block width 5 - 17.5 mm; stretchable 5 - 5.2 mm; plain; snap-on type; brown</p> 	<p><b>Item No.: 793-5501/000-007</b> WMB marking card; as card; for terminal block width 5 - 17.5 mm; stretchable 5 - 5.2 mm; plain; snap-on type; gray</p> 
<p><b>Item No.: 793-5501/000-023</b> WMB marking card; as card; for terminal block width 5 - 17.5 mm; stretchable 5 - 5.2 mm; plain; snap-on type; green</p> 	<p><b>Item No.: 793-5501/000-017</b> WMB marking card; as card; for terminal block width 5 - 17.5 mm; stretchable 5 - 5.2 mm; plain; snap-on type; light green</p> 	<p><b>Item No.: 793-5501/000-012</b> WMB marking card; as card; for terminal block width 5 - 17.5 mm; stretchable 5 - 5.2 mm; plain; snap-on type; orange</p> 	<p><b>Item No.: 793-5501/000-005</b> WMB marking card; as card; for terminal block width 5 - 17.5 mm; stretchable 5 - 5.2 mm; plain; snap-on type; red</p> 
<p><b>Item No.: 793-5501/000-024</b> WMB marking card; as card; for terminal block width 5 - 17.5 mm; stretchable 5 - 5.2 mm; plain; snap-on type; violet</p> 	<p><b>Item No.: 793-5501</b> WMB marking card; as card; for terminal block width 5 - 17.5 mm; stretchable 5 - 5.2 mm; plain; snap-on type; white</p> 	<p><b>Item No.: 793-5501/000-002</b> WMB marking card; as card; for terminal block width 5 - 17.5 mm; stretchable 5 - 5.2 mm; plain; snap-on type; yellow</p> 	<p><b>Item No.: 2009-115/000-006</b> WMB-Inline; for Smart Printer; 1500 pieces on roll; stretchable 5 - 5.2 mm; plain; snap-on type; blue</p> 
<p><b>Item No.: 2009-115/000-007</b> WMB-Inline; for Smart Printer; 1500 pieces on roll; stretchable 5 - 5.2 mm; plain; snap-on type; gray</p> 	<p><b>Item No.: 2009-115/000-023</b> WMB-Inline; for Smart Printer; 1500 pieces on roll; stretchable 5 - 5.2 mm; plain; snap-on type; green</p> 	<p><b>Item No.: 2009-115/000-017</b> WMB-Inline; for Smart Printer; 1500 pieces on roll; stretchable 5 - 5.2 mm; plain; snap-on type; light green</p> 	<p><b>Item No.: 2009-115/000-012</b> WMB-Inline; for Smart Printer; 1500 pieces on roll; stretchable 5 - 5.2 mm; plain; snap-on type; orange</p> 
<p><b>Item No.: 2009-115/000-005</b> WMB-Inline; for Smart Printer; 1500 pieces on roll; stretchable 5 - 5.2 mm; plain; snap-on type; red</p> 	<p><b>Item No.: 2009-115/000-024</b> WMB-Inline; for Smart Printer; 1500 pieces on roll; stretchable 5 - 5.2 mm; plain; snap-on type; violet</p> 	<p><b>Item No.: 2009-115</b> WMB-Inline; for Smart Printer; 1500 pieces on roll; stretchable 5 - 5.2 mm; plain; snap-on type; white</p> 	<p><b>Item No.: 2009-115/000-002</b> WMB-Inline; for Smart Printer; 1500 pieces on roll; stretchable 5 - 5.2 mm; plain; snap-on type; yellow</p> 



### 1.2.8.2 Marking strip



**Item No.: 2009-110**

Marking strips; for Smart Printer; on reel; not stretchable; plain; snap-on type; white

### 1.2.9 Protective warning marker

#### 1.2.9.1 Cover



**Item No.: 2002-115**

Protective warning marker; for 5 terminal blocks; with high-voltage symbol, black; yellow

### 1.2.10 Screwless end stop

#### 1.2.10.1 Mounting accessories



**Item No.: 249-117**

Screwless end stop; 10 mm wide; for DIN-rail 35 x 15 and 35 x 7.5; gray



**Item No.: 249-116**

Screwless end stop; 6 mm wide; for DIN-rail 35 x 15 and 35 x 7.5; gray

### 1.2.11 Test and measurement

#### 1.2.11.1 Testing accessories



**Item No.: 210-136**

Test plug; 2 mm Ø; with 500 mm cable; red

### 1.2.12 Tool

#### 1.2.12.1 Operating tool



**Item No.: 210-658**

Operating tool; Blade: 3.5 x 0.5 mm; with a partially insulated shaft; angled; short; multicoloured



**Item No.: 210-720**

Operating tool; Blade: 3.5 x 0.5 mm; with a partially insulated shaft; multicoloured

Installation Notes

Conductor termination

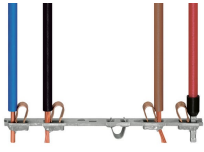

All conductor types at a glance

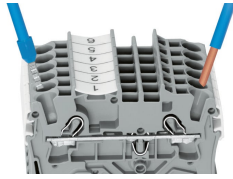

Push-in termination of solid and ferruled conductors

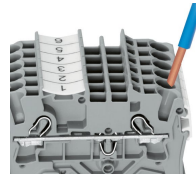

**Inserting a conductor via push-in termination:**  
Solid conductors with cross-sections from either one size above, or up to two sizes below, the rated cross-section can be simply pushed in – no tools needed.

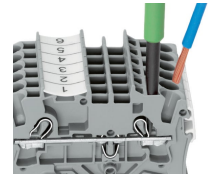

**Inserting a conductor via operating tool:**  
Connecting fine-stranded conductors without ferrules, or small cross-sectional conductors that cannot be pushed in, is performed similarly to the original CAGE CLAMP® – just use an operating tool.  
**Advantage:**  
To open the clamp, the operating tool is inserted vertically. The conductor entry is less than 15 degrees for easier wiring.

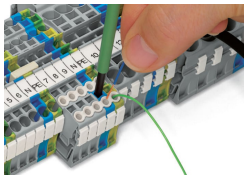

Conductor termination – insulation stop

Commoning

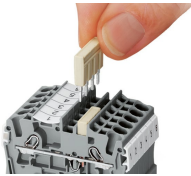

Insert push-in type jumper bar and push down until it hits backstop.

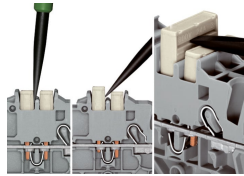

**Removing a push-in type jumper bar:**  
Insert the operating tool between the jumper and partition wall of the dual jumper slots, then lift up the jumper.  
Place the operating tool in the center of jumpers for up to five contacts (see above), or alternately on both sides for jumpers with more than five contacts.



Fuse terminal blocks with a width of 6.2 mm/0.244 in can be assembled adjacently. If there is no adjacent fuse terminal block at the end of the assembly, an end plate must be used.

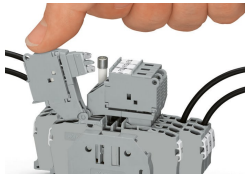

Fused Disconnect Terminal Block with a Pivoting Fuse Holder  
Pivot the fuse holder into the locked open position.

Fused disconnect terminal block with a pivoting fuse holder  
Fuse replacement

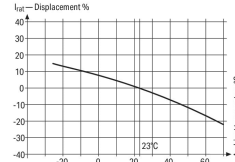
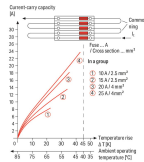
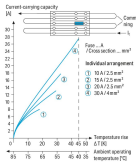

Information from the mini-automotive, blade-type fuse manufacturers

Standard	I <sub>cc</sub> [%]	F <sub>1</sub>
15	14	0.877
15	15	0.884
15	17	0.909
15	18	0.920
15	20	0.937
15	25	0.974
15	30	1.000
15	35	1.024
15	40	1.044
15	45	1.061
15	50	1.075
15	55	1.087
15	60	1.097
15	65	1.105
15	70	1.111
15	75	1.115
15	80	1.119
15	85	1.122
15	90	1.125

**Application Notes on Terminal Blocks for Glass Cartridge Fuses**  
Diagram: "Individual Arrangement"

**Application Notes on Terminal Blocks for Glass Cartridge Fuses**  
Diagram: "Block Arrangement"

**Application Notes on Terminal Blocks for Glass Cartridge Fuses**  
Nominal current ratings for fuse cartridges are defined differently in international standards. This is why the recommended continuous current-carrying capacity of the fuses is a max. 80% of their nominal current according to DIN 72581/Part 3 (for a surrounding air temperature of 23°C).  
Selecting the correct fuse cartridge is important for product safety within applications, as well as for fuse cartridge service life and reliability. Fuse cartridges will only operate perfectly as protection components (break-off point) if they are properly selected and used as intended (i.e., according to the state of the technology and valid specifications, as well as data sheet characteristics), according to basic safety requirements (i.e., persons, animals and property must be protected against hazards).

Concerning product safety, fuse cartridges must generally be tested under both normal and faulty operating conditions within your application.

**Marking**

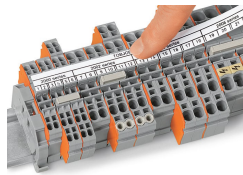
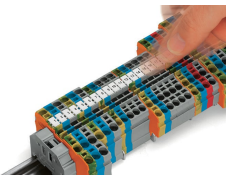

Snapping WMB Inline markers into marker slots.