

SCM 4CO P**Weidmüller Interface GmbH & Co. KG**

Klingenbergstraße 26

D-32758 Detmold

Germany

www.weidmueller.com

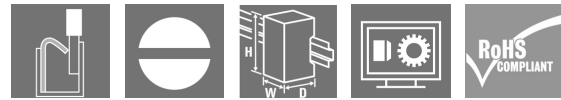
Product image

Relay sockets for the D-SERIES DRM relays

- 2 and 4 CO contacts
- Screw and PUSH IN connection
- Standard and low heights

General ordering data

Version	D-SERIES DRM, Relay socket, Number of contacts: 4, CO contact, Continuous current: 6 A, PUSH IN
Order No.	7760056363
Type	SCM 4CO P
GTIN (EAN)	6944169772276
Qty.	10 pc(s).

Creation date March 22, 2024 3:29:13 PM CET

Catalogue status 09.03.2024 / We reserve the right to make technical changes.

SCM 4CO P

Weidmüller Interface GmbH & Co. KG

Klingenbergstraße 26

D-32758 Detmold

Germany

www.weidmueller.com

Technical data

Dimensions and weights

Depth	42.7 mm	Depth (inches)	1.681 inch
Height	101.8 mm	Height (inches)	4.008 inch
Width	30.6 mm	Width (inches)	1.205 inch
Net weight	71.12 g		

Temperatures

Storage temperature	-40 °C...85 °C	Operating temperature	-40 °C...55 °C
Humidity	5...85 %, no condensation		

Rated data UL

Certificate No. (cURus)	E355547
-------------------------	---------

Load side

Rated switching voltage	250 V AC	Continuous current	6 A
Max. switching voltage, AC	250 V	Contact type	4 CO contact

General data

Rail	TS 35		
Colour	black		
UL94 flammability rating component	Component	Retaining clip	
	UL94 flammability rating	HB	
	Component	Mounting foot	
	UL94 flammability rating	HB	
	Component	Pusher	
	UL94 flammability rating	HB	
Component	Housing		
	UL94 flammability rating		V-2

Insulation coordination

Rated voltage	250 V	Pollution severity	2
Surge voltage category	III	Insulating material group	IIIb
Clearance and creepage distances for control side - load side	≥ 3 mm	Dielectric strength for control side - load side	4 kV _{eff} / 1 min
Dielectric strength of neighbouring contacts	2.5 kV _{eff} / 1 Min.	Dielectric strength of open contact	2.5 kV _{eff} / 1 Min.
Impulse withstand voltage at neighbouring contacts	4.8 kV (1.2/50 µs)	Protection degree	IP20

Further details of approvals / standards

Certificate No. (cURus)	E355547
-------------------------	---------

SCM 4CO P

Weidmüller Interface GmbH & Co. KG

Klingenbergstraße 26

D-32758 Detmold

Germany

www.weidmueller.com

Technical data

Connection data

Wire connection method	PUSH IN	Stripping length, rated connection	10 mm
Clamping range, rated connection	1.5 mm ²	Clamping range, min.	0.14 mm ²
Clamping range, max.	1.5 mm ²	Wire connection cross section AWG, min.	AWG 26
Wire connection cross section AWG, max.	AWG 16	Wire cross-section, solid, min.	0.14 mm ²
Wire cross-section, solid, max.	1.5 mm ²	Wire connection cross section, finely stranded, min.	0.14 mm ²
Wire connection cross section, finely stranded, max.	1.5 mm ²	Wire connection cross-section, finely stranded with wire-end ferrules DIN 46228/4, min.	0.14 mm ²
Wire connection cross-section, finely stranded with wire-end ferrules DIN 46228/4, max.	1 mm ²	Conductor cross-section, flexible, AEH (DIN 46228-1), min.	0.14 mm ²
Conductor cross-section, flexible, AEH (DIN 46228-1), max.	1.5 mm ²	Blade size	0.4 x 2.5 mm

Classifications

ETIM 6.0	EC001456	ETIM 7.0	EC001456
ETIM 8.0	EC001456	ETIM 9.0	EC001456
ECLASS 9.0	27-37-16-03	ECLASS 9.1	27-37-16-03
ECLASS 10.0	27-37-16-03	ECLASS 11.0	27-37-16-03
ECLASS 12.0	27-37-16-03	ECLASS 13.0	27-37-16-03

Important note

Product information Only connection A2 with the cross-connection SCM/SDI P CC (art. no. 7760056366) can be bridged on this socket.

Approvals

Approvals



ROHS	Conform
UL File Number Search	UL Website
Certificate No. (cURus)	E355547

Downloads

Approval/Certificate/Document of Conformity	EU Konformitätserklärung / EU Declaration of Conformity
Engineering Data	CAD data – STEP
Catalogues	Catalogues in PDF-format

SCM 4CO P

Weidmüller Interface GmbH & Co. KG
 Klingenbergstraße 26
 D-32758 Detmold
 Germany

www.weidmueller.com

Drawings

Wiring diagram

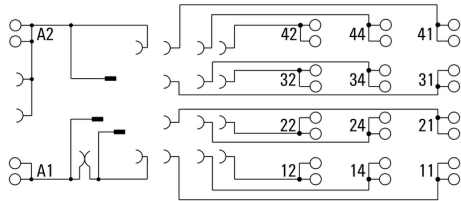

Dimensional drawing

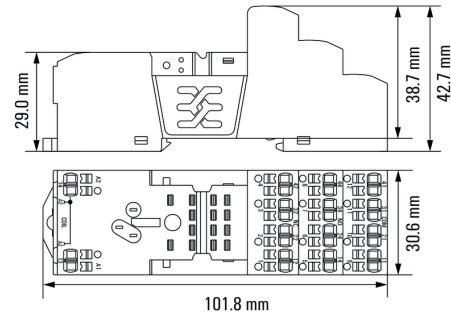

Example of use

How to install marker

on PUSH IN connection sockets (one slot available)

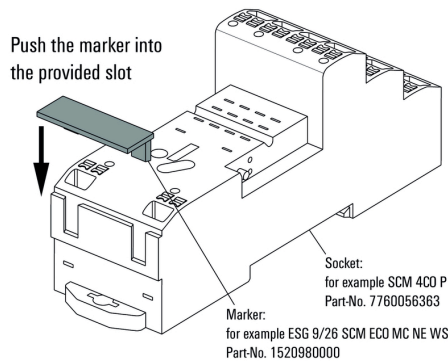



How to install marker

on PUSH IN connection sockets (one slot available)

Miscellaneous

Removal of cables

-  stranded with ferrule
-  stranded without ferrule
-  solid

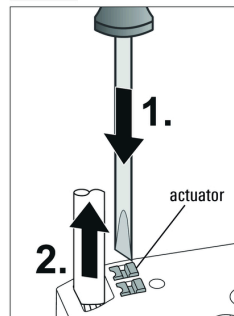

Wires will be disconnected just when opening the terminal with the actuator.

Miscellaneous

Insert flexible and solid cables

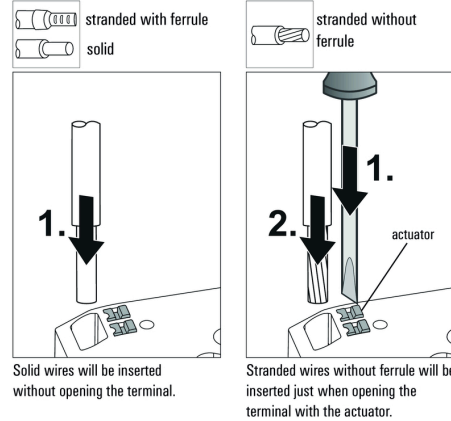

Solid wires will be inserted without opening the terminal.

Stranded wires without ferrule will be inserted just when opening the terminal with the actuator.

Miscellaneous

Recommended screwdriver

to push the actuator in PUSH IN

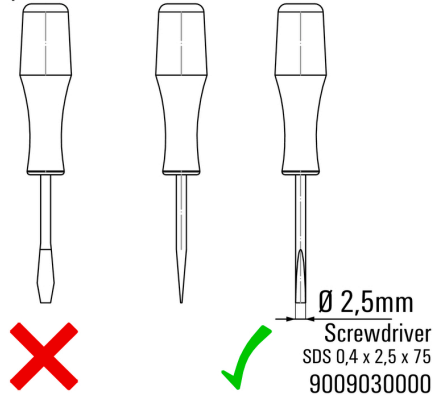

SCM 4CO P

Weidmüller Interface GmbH & Co. KG
 Klingenbergstraße 26
 D-32758 Detmold
 Germany

www.weidmueller.com

Accessories

Cross-connection for socket with PUSH IN connection

Cross-connection for the sockets in the D-SERIES DRI.

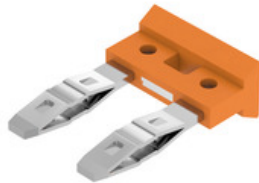

General ordering data

Type	SCM/SDI P CC	Version
Order No.	7760056366	D-SERIES, Cross-connector
GTIN (EAN)	6944169773327	
Qty.	10 pc(s).	

Protection modules

Pluggable protective modules for the D-SERIES relay sockets, with optional protective functions.

- With free-wheeling diode or RC filter



General ordering data

Type	RIM 3 110/230VAC	Version
Order No.	7760056014	D-SERIES, RC filter, Rated control voltage: 110...230 V AC, Plug-in connection
GTIN (EAN)	4032248878109	
Qty.	10 pc(s).	
Type	RIM 1 6/230VDC	Version
Order No.	7760056169	D-SERIES, Free-wheeling diode, Rated control voltage: 6...230 V, Plug-in connection
GTIN (EAN)	4032248967728	
Qty.	10 pc(s).	
Type	RIM 3 110/230VAC LED	Version
Order No.	7760056045	D-SERIES, RC filter, Rated control voltage: 110...230 V AC, Plug-in connection
GTIN (EAN)	4032248878147	
Qty.	10 pc(s).	

SCM 4CO P

Weidmüller Interface GmbH & Co. KG
 Klingenbergstraße 26
 D-32758 Detmold
 Germany

www.weidmueller.com

Accessories

LED



Pluggable protective modules for the D-SERIES relay sockets, with optional protective functions.

- With green LED

General ordering data

Type	RIM 3 6/24VUC	Version
Order No.	7940018457	D-SERIES, LED module, Rated control voltage: 6...24 V UC, Plug-in connection
GTIN (EAN)	4032248878192	
Qty.	10 pc(s).	
Type	RIM 3 110/230VUC	Version
Order No.	7940018455	D-SERIES, LED module, Rated control voltage: 110...230 V UC, Plug-in connection
GTIN (EAN)	4032248878185	
Qty.	10 pc(s).	
Type	RIM 3 24/60VUC	Version
Order No.	7760056018	D-SERIES, LED module, Rated control voltage: 24...60 V UC, Plug-in connection
GTIN (EAN)	4032248878130	
Qty.	10 pc(s).	

Blank



ESG is the tried-and-tested marker in MultiCard format for use on many well-known electrical devices. The result is high-quality device marking with a high-contrast appearance.

Various types are available for devices from manufacturers like Siemens, ABB, Beckhoff etc.

Advantages at a glance:

- Tags for universal usage, self-adhesive or clip-on tags, depending on type
- For aligned equipment, e.g. circuit breakers, we supply ESG markers for clipping onto tag rails
- Individual laser-quality printing according to specifications

For custom printing: Please send us a file of our labeling software M-Print PRO or M-Print PRO Online (without installation) for your labeling specifications.

General ordering data

Type	ESG 9/26 SCM ECO MC NE ...	Version
Order No.	1520990000	ESG, Device markers x 26 mm, PA 66, Colour: yellow
GTIN (EAN)	4050118327861	
Qty.	80 pc(s).	

SCM 4CO P

Weidmüller Interface GmbH & Co. KG
 Klingenbergstraße 26
 D-32758 Detmold
 Germany

www.weidmueller.com

Accessories

Type	ESG 9/26 SCM ECO MC NE ...	Version
Order No.	1520980000	ESG, Device markers x 26 mm, PA 66, Colour: white
GTIN (EAN)	4050118327939	
Qty.	80 pc(s).	

Type	ESG 9/26 SCM ECO MC NE ...	Version
Order No.	1521000000	ESG, Device markers x 26 mm, PA 66, Colour: grey
GTIN (EAN)	4050118327878	
Qty.	80 pc(s).	

LED / free-wheel diode



Pluggable protective modules for the D-SERIES relay sockets, with optional protective functions.

- With green LED and free-wheeling diode

General ordering data

Type	RIM 2 110/230VDC	Version
Order No.	7760056017	D-SERIES, LED module with freewheel diode, Rated control voltage:
GTIN (EAN)	4032248896615	110...230 V DC, Plug-in connection
Qty.	10 pc(s).	

Type	RIM 2 24/60VDC	Version
Order No.	7760056016	D-SERIES, LED module with freewheel diode, Rated control voltage:
GTIN (EAN)	4032248878123	24...60 V DC, Plug-in connection
Qty.	10 pc(s).	

Type	RIM 2 6/24VDC	Version
Order No.	7760056015	D-SERIES, LED module with freewheel diode, Rated control voltage:
GTIN (EAN)	4032248878116	6...24 V DC, Plug-in connection
Qty.	10 pc(s).	

SCM 4CO P

Weidmüller Interface GmbH & Co. KG

Klingenbergstraße 26

D-32758 Detmold

Germany

www.weidmueller.com

Accessories

Slotted screwdriver



VDE insulated slot-head screwdriver, SDI DIN 7437, ISO 2380/2, drive output acc. to DIN 5264, ISO 2380/1. SoftFinish grip

General ordering data

Type	SDIS 0.4X2.5X75	Version
Order No.	2749790000	Screwdriver, Blade width (B): 2.5 mm, Blade length: 75 mm, Blade thickness (A): 0.4 mm
GTIN (EAN)	4050118896534	
Qty.	1 pc(s).	

Slotted screwdriver

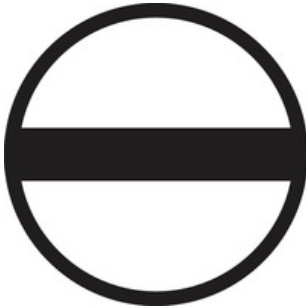

Slotted screwdriver with rounded blade SD DIN 5265, ISO 2380/2, output to DIN 5264, ISO 2380/1. ChromTop tip, SoftFinish grip

General ordering data

Type	SDS 0.4X2.5X75	Version
Order No.	2749320000	Screwdriver, Blade width (B): 2.5 mm, Blade length: 75 mm, Blade thickness (A): 0.4 mm
GTIN (EAN)	4050118895544	
Qty.	1 pc(s).	

SCM 4CO P

Weidmüller Interface GmbH & Co. KG
 Klingenbergstraße 26
 D-32758 Detmold
 Germany

www.weidmueller.com

Accessories

Retaining clips



Retaining clip for D-SERIES DRM relays
 • Metal and plastic retaining clip

General ordering data

Type	DRM/DRL CLIP M	Version
Order No.	7760056108	D-SERIES, Retaining clip
GTIN (EAN)	4032248855568	
Qty.	10 pc(s).	
Type	SCM CLIP P	Version
Order No.	7760056367	D-SERIES DRM, Retaining clip
GTIN (EAN)	6944169773334	
Qty.	5 pc(s).	

Custom printing



ESG is the tried-and-tested marker in MultiCard format for use on many well-known electrical devices. The result is high-quality device marking with a high-contrast appearance.

Various types are available for devices from manufacturers like Siemens, ABB, Beckhoff etc.

Advantages at a glance:

- Tags for universal usage, self-adhesive or clip-on tags, depending on type
- For aligned equipment, e.g. circuit breakers, we supply ESG markers for clipping onto tag rails
- Individual laser-quality printing according to specifications

For custom printing: Please send us a file of our labeling software M-Print PRO or M-Print PRO Online (without installation) for your labeling specifications.

General ordering data

Type	ESG 9/26 SCM ECO MC SDR	Version
Order No.	1525800000	ESG, Device markers x 26 mm, PA 66, Colour: To customer specification
GTIN (EAN)	4050118331875	
Qty.	80 pc(s).	