

Product datasheet

Specifications



selector switch head Ø22 2-position stay put Ronis 455



Local distributor code: 237189228 ZB5AG4

EAN Code : 3389110905823

Main

Range of product	Harmony XB5
Product or component type	Head for key selector switch
Device short name	ZB5
Bezel material	Dark grey plastic
Mounting diameter	22 mm
Head type	Standard
Sale per indivisible quantity	1
Shape of signaling unit head	Round
Type of operator	stay put
Operator profile	Black key switch
Operator position information	2 positions 90°
Type of keylock	Key 455
Key withdrawal position	In any position

Complementary

CAD overall width	29 mm
CAD overall height	29 mm
CAD overall depth	72 mm
Net weight	0.057 kg
Mechanical durability	1000000 cycles
Station name	XALD 1...5 cut-outs XALK 2...5 cut-outs

Electrical composition code	C4 for <6 contacts using single and double blocks in front mounting C5 for <5 contacts using single blocks in front mounting C6 for <5 contacts using single and double blocks in front mounting C7 for <4 contacts using single blocks in front mounting C8 for <4 contacts using single and double blocks in front mounting C11 for <3 contacts using single blocks in front mounting C3 for <6 contacts using single blocks in front mounting SF1 for <3 contacts using single blocks in front mounting SR1 for <3 contacts using single blocks in rear mounting C15 for <1 contacts using single blocks in front mounting
-----------------------------	--

Device presentation	Basic element
---------------------	---------------

Environment

Protective treatment	TH
Ambient air temperature for storage	-40...70 °C
Ambient air temperature for operation	-40...70 °C
Overvoltage category	Class II conforming to IEC 60536
IP degree of protection	IP66 conforming to IEC 60529 IP67 IP69 IP69K
NEMA degree of protection	NEMA 13 NEMA 4X
Resistance to high pressure washer	7000000 Pa at 55 °C, distance : 0.1 m
IK degree of protection	IK06 conforming to IEC 50102
Standards	UL 508 EN/IEC 60947-5-1 EN/IEC 60947-5-4 JIS C8201-5-1 CSA C22.2 No 14 EN/IEC 60947-1 JIS C8201-1
Product certifications	DNV LROS (Lloyds register of shipping) BV CSA GL UL listed
Vibration resistance	5 gn (f= 2...500 Hz) conforming to IEC 60068-2-6
Shock resistance	30 gn (duration = 18 ms) for half sine wave acceleration conforming to IEC 60068-2-27 50 gn (duration = 11 ms) for half sine wave acceleration conforming to IEC 60068-2-27

Packing Units

Unit Type of Package 1	PCE
Number of Units in Package 1	1
Package 1 Height	9.000 cm
Package 1 Width	5.200 cm
Package 1 Length	3.300 cm
Package 1 Weight	66.000 g
Unit Type of Package 2	BB1
Number of Units in Package 2	5
Package 2 Height	9.000 cm
Package 2 Width	3.300 cm
Package 2 Length	26.500 cm
Package 2 Weight	335.000 g
Unit Type of Package 3	S03
Number of Units in Package 3	150
Package 3 Height	30.000 cm
Package 3 Width	30.000 cm
Package 3 Length	40.000 cm
Package 3 Weight	10.330 kg

Offer Sustainability









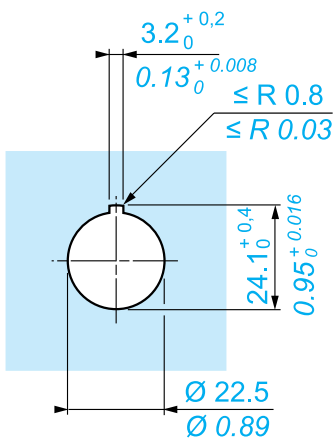
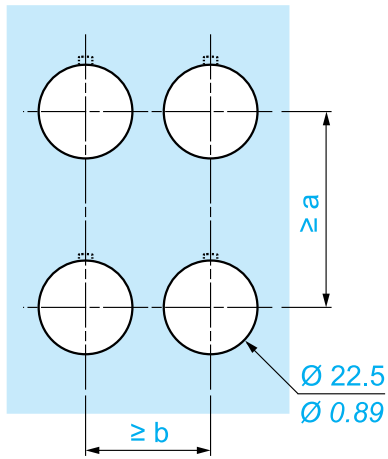
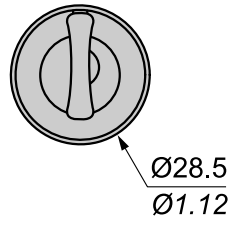
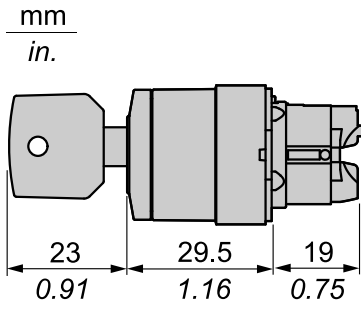

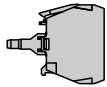
Sustainable offer status	Green Premium product
REACH Regulation	REACH Declaration
EU RoHS Directive	Pro-active compliance (Product out of EU RoHS legal scope) EU RoHS Declaration
Mercury free	Yes
China RoHS Regulation	China RoHS declaration
RoHS exemption information	Yes
Environmental Disclosure	Product Environmental Profile
Circularity Profile	End of Life Information

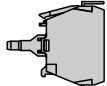
Contractual warranty

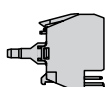
Warranty	18 months
----------	-----------

Dimensions

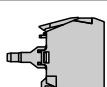

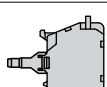
		a (mm)	a (in.)	b (mm)	b (in.)
		40	1.57	30	1.18
ZBE●●●●●	ZBV●●●●●				
		45	1.77	32	1.26
ZBE●●●●●3	ZBV●●●●●3				
		40	1.57	30	1.18
ZBE●●●●●4	ZBV●●●●●4				
		50	1.97	30	1.18
ZBE●●●●●5	ZBV●●●●●5				
		40	1.57	30	1.18
ZBE●●●●●9	ZBV●●●●●9				
		40	1.57	30	1.18
ZBRT●	ZBRV1				

Recommended replacement(s)