

# Product datasheet

Specifications



## selector switch head Ø22 3-position stay put Ronis 455



Local distributor code: 237189215 ZB5AG3

EAN Code : 3389110905816

### Main

|                               |                              |
|-------------------------------|------------------------------|
| Range of product              | Harmony XB5                  |
| Product or component type     | Head for key selector switch |
| Device short name             | ZB5                          |
| Bezel material                | Dark grey plastic            |
| Mounting diameter             | 22 mm                        |
| Head type                     | Standard                     |
| Sale per indivisible quantity | 1                            |
| Shape of signaling unit head  | Round                        |
| Type of operator              | stay put                     |
| Operator profile              | Black key switch             |
| Operator position information | 3 positions +/- 45°          |
| Type of keylock               | Key 455                      |
| Key withdrawal position       | Center                       |

### Complementary

|                       |  |
|-----------------------|--|
| CAD overall width     | 29 mm                                      |
| CAD overall height    | 29 mm                                      |
| CAD overall depth     | 72 mm                                      |
| Net weight            | 0.057 kg                                   |
| Mechanical durability | 1000000 cycles                             |
| Station name          | XALD 1...5 cut-outs<br>XALK 2...5 cut-outs |

|                             |   |
|-----------------------------|---|
| Electrical composition code | C4 for <6 contacts using single and double blocks in front mounting<br>C5 for <5 contacts using single blocks in front mounting<br>C6 for <5 contacts using single and double blocks in front mounting<br>C7 for <4 contacts using single blocks in front mounting<br>C8 for <4 contacts using single and double blocks in front mounting<br>C11 for <3 contacts using single blocks in front mounting<br>C3 for <6 contacts using single blocks in front mounting<br>SF1 for <3 contacts using single blocks in front mounting<br>SR1 for <3 contacts using single blocks in rear mounting |
|-----------------------------|---|

|                     |               |
|---------------------|---------------|
| Device presentation | Basic element |
|---------------------|---------------|

## Environment

|                                       |  |
|---------------------------------------|--|
| Protective treatment                  | TH   |
| Ambient air temperature for storage   | -40...70 °C  |
| Ambient air temperature for operation | -40...70 °C  |
| Overvoltage category                  | Class II conforming to IEC 60536   |
| IP degree of protection               | IP66 conforming to IEC 60529<br>IP67<br>IP69<br>IP69K  |
| NEMA degree of protection             | NEMA 13<br>NEMA 4X   |
| Resistance to high pressure washer    | 7000000 Pa at 55 °C, distance : 0.1 m  |
| IK degree of protection               | IK06 conforming to IEC 50102   |
| Standards                             | EN/IEC 60947-1<br>EN/IEC 60947-5-1<br>JIS C8201-5-1<br>CSA C22.2 No 14<br>EN/IEC 60947-5-4<br>UL 508<br>JIS C8201-1  |
| Product certifications                | DNV<br>UL listed<br>GL<br>BV<br>CSA<br>LROS (Lloyds register of shipping)  |
| Vibration resistance                  | 5 gn (f= 2...500 Hz) conforming to IEC 60068-2-6   |
| Shock resistance                      | 30 gn (duration = 18 ms) for half sine wave acceleration conforming to IEC 60068-2-27<br>50 gn (duration = 11 ms) for half sine wave acceleration conforming to IEC 60068-2-27 |

## Packing Units

|                              |           |
|------------------------------|-----------|
| Unit Type of Package 1       | PCE       |
| Number of Units in Package 1 | 1         |
| Package 1 Height             | 3.6 cm    |
| Package 1 Width              | 5.5 cm    |
| Package 1 Length             | 9 cm      |
| Package 1 Weight             | 68 g      |
| Unit Type of Package 2       | S03       |
| Number of Units in Package 2 | 150       |
| Package 2 Height             | 30 cm     |
| Package 2 Width              | 30 cm     |
| Package 2 Length             | 40 cm     |
| Package 2 Weight             | 10.582 kg |

## Offer Sustainability

|                          |   |
|--------------------------|---|
| Sustainable offer status | Green Premium product   |
| REACH Regulation         | <a href="#">REACH Declaration</a>   |
| EU RoHS Directive        | Pro-active compliance (Product out of EU RoHS legal scope)<br><a href="#">EU RoHS Declaration</a> |
| Mercury free             | Yes   |

---

|                                   |   |
|-----------------------------------|---|
| <b>China RoHS Regulation</b>      | <a href="#">China RoHS declaration</a>        |
| <b>RoHS exemption information</b> | <a href="#">Yes</a>                           |
| <b>Environmental Disclosure</b>   | <a href="#">Product Environmental Profile</a> |
| <b>Circularity Profile</b>        | <a href="#">End of Life Information</a>       |

---









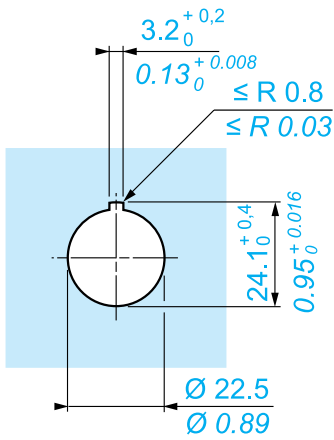
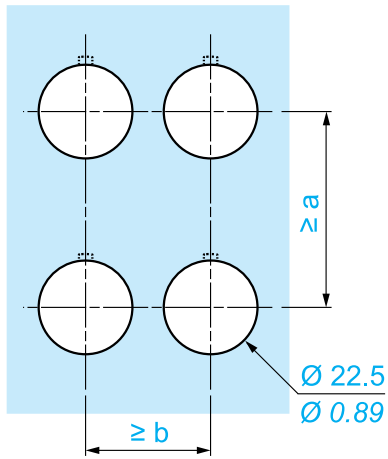
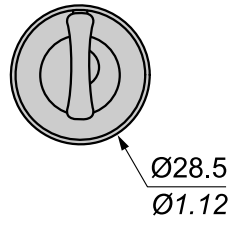
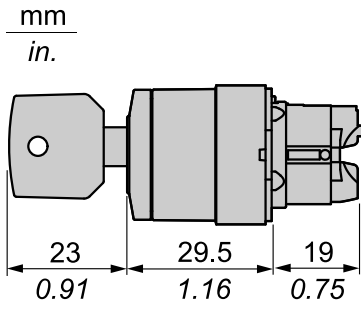

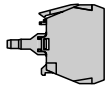
## **Contractual warranty**

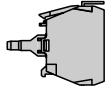
---

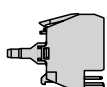
|                 |           |
|-----------------|-----------|
| <b>Warranty</b> | 18 months |
|-----------------|-----------|

**Dimensions**

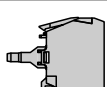

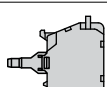
|   |   | a (mm) | a (in.) | b (mm) | b (in.) |
|---|---|--------|---------|--------|---------|
|    |    | 40     | 1.57    | 30     | 1.18    |
| ZBE●●●●●  | ZBV●●●●●  |        |         |        |         |
|   |   | 45     | 1.77    | 32     | 1.26    |
| ZBE●●●●●3   | ZBV●●●●●3   |        |         |        |         |
|  |  | 40     | 1.57    | 30     | 1.18    |
| ZBE●●●●●4   | ZBV●●●●●4   |        |         |        |         |
|  |  | 50     | 1.97    | 30     | 1.18    |
| ZBE●●●●●5   | ZBV●●●●●5   |        |         |        |         |
|  |  | 40     | 1.57    | 30     | 1.18    |
| ZBE●●●●●9   | ZBV●●●●●9   |        |         |        |         |
|  |  | 40     | 1.57    | 30     | 1.18    |
| ZBRT●   | ZBRV1   |        |         |        |         |

**Recommended replacement(s)**