

Data Sheet | Item Number: 285-1185

2-conductor through terminal block; 185 mm²; lateral marker slots; only for DIN 35 x 15 rail; POWER CAGE CLAMP; 185,00 mm²; gray

<https://www.wago.com/285-1185>

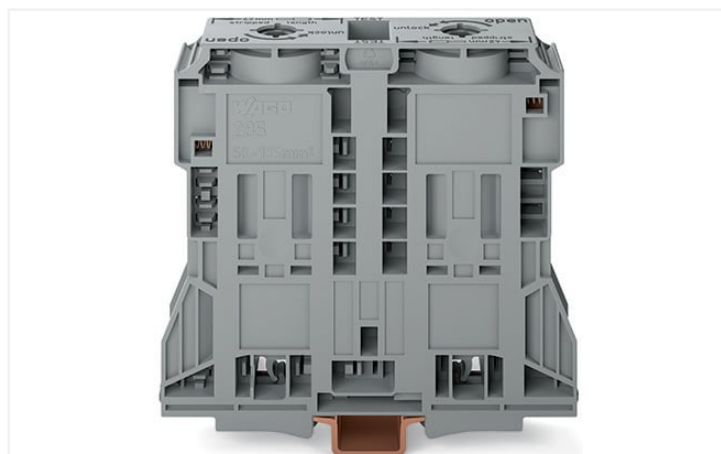
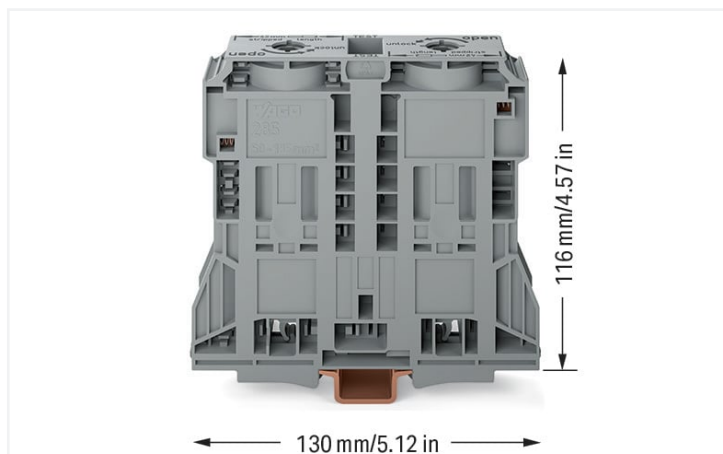

Color: gray

Electrical data

Ratings per IEC/EN

Ratings per	IEC/EN 60947-7-1
Nominal voltage (III/3)	1000 V
Rated impulse voltage (III/3)	12 kV
Rated current	353 A
Legend (ratings)	(III / 3) Δ Overvoltage category III / Pollution degree 3

Ratings per IEC/EN 2

Rated voltage (III/3) 2	1500 V
Rated surge voltage (III/3) 2	12 kV

Ratings per UL 1059

Approvals per	UL 1059
Rated voltage UL (Use Group B)	600 V
Rated current UL (Use Group B)	310 A
Rated voltage UL (Use Group C)	600 V
Rated current UL (Use Group C)	310 A

Ratings per CSA

Approvals per	CSA 22.2 No 158
Rated voltage CSA (Use Group B)	1000 V
Rated current CSA (Use Group B)	310 A
Rated voltage CSA (Use Group C)	1000 V
Rated current CSA (Use Group D)	310 A

Power loss

Power loss, per pole (potential)	11.2148 W
Rated current I_N for specified power loss	353 A
Resistance value for specified, current-dependent power loss	9e-005 Ω

General

Voltage type 1	AC/DC
Voltage type 2	DC

Connection data

Connection points	2
Total number of potentials	1
Number of levels	1
Number of jumper slots	2

Connection 1

Connection technology	POWER CAGE CLAMP
Actuation type	T-wrench; 8 mm
Connectable conductor materials	Copper
Nominal cross-section	185 mm ² / 350 kcmil
Solid conductor	50 ... 185 mm ² / 1/0 AWG ... 350 kcmil
Stranded conductor	50 ... 185 mm ² / 1/0 AWG ... 350 kcmil
Fine-stranded conductor	50 ... 185 mm ² / 1/0 AWG ... 350 kcmil

Connection 1

Fine-stranded conductor; with insulated ferrule	50 ... 150 mm ² / 1/0 AWG ... 300 kcmil
Fine-stranded conductor; with uninsulated ferrule	50 ... 185 mm ² / 1/0 AWG ... 350 kcmil
Strip length	45 ... 47 mm / 1.77 ... 1.85 inches
Wiring direction	Side-entry wiring

Physical data

Width	32 mm / 1.26 inches
Height	130 mm / 5.118 inches
Depth from upper-edge of DIN-rail	116 mm / 4.567 inches

Mechanical data

Mounting type	DIN-rail 35 x 15
Mounting (note)	only suitable for DIN 35 x 15 rail
Marking level	Side marking

Material data

Note (material data)	Information on material specifications can be found here
Color	gray
Material group	I
Insulation material	Polyamide (PA66)
Flammability class per UL94	V0
Fire load	5.832 MJ
Weight	534.9 g

Environmental requirements

Processing temperature	-35 ... +85 °C
Continuous operating temperature	-60 ... +105 °C

Commercial data

Product Group	1 (Rail Mounted Terminal Blocks)
eCl@ss 10.0	27-14-11-20
eCl@ss 9.0	27-14-11-20
ETIM 8.0	EC000897
ETIM 7.0	EC000897
PU (SPU)	5 pcs
Packaging type	Box
Country of origin	DE
GTIN	4055143067065
Customs tariff number	85369010000

Approvals / Certificates

General approvals



Approval	Standard	Certificate Name
CCA DEKRA Certification B.V.	EN 60947	NTR NL 7965
CSA DEKRA Certification B.V.	C22.2 No. 158	154112
KEMA/KEUR DEKRA Certification B.V.	EN 60947	71-126013
UL Underwriters Laboratories Inc.	UL 1059	E45172

Declarations of conformity and manufacturer's declarations

Approval	Standard	Certificate Name
EU-Declaration of Conformity WAGO GmbH & Co. KG	-	-
UK-Declaration of Conformity WAGO GmbH & Co. KG	-	-

Approvals for marine applications



Approval	Standard	Certificate Name
ABS American Bureau of Shipping	EN 60947	20-HG1941090-PDA
DNV GL Det Norske Veritas, Germanischer Lloyd	-	TAE00001V2

Downloads

Environmental Product Compliance

Compliance Search

Environmental Product Compliance 285-1185	↓
-------------------------------------------	-------------------

Documentation





Additional Information

Technical Section	pdf 2142.18 KB	↓
-------------------	-------------------	-------------------

Bid Text

285-1185	19.02.2019	xml 3.88 KB	↓
285-1185	04.01.2018	doc 25.50 KB	↓

CAD/CAE-Data

CAD data	CAE data
2D/3D Models 285-1185 	EPLAN Data Portal 285-1185 
	WSCAD Universe 285-1185 
	ZUKEN Portal 285-1185 

1 Compatible Products

1.1 Optional Accessories

1.1.1 Cover

1.1.1.1 Cover



Item No.: 285-1178

Finger guard; touchproof cover protects unused conductor entries and jumper slots; for 185 mm² high-current terminal blocks; yellow

1.1.2 Current and voltage tap

1.1.2.1 Current and voltage tap



Item No.: 855-1851/350-000

Current and voltage tap up to 185 mm²; Primary rated current: 350 A; Secondary rated current: 1 A; Rated power: 0.2 VA; Accuracy class: 0.5; fused

1.1.3 DIN-rail

1.1.3.1 Mounting accessories



Item No.: 210-198

Copper carrier rail; 35 x 15 mm; 2.3 mm thick; 2 m long; unslotted; according to EN 60715; copper-colored



Item No.: 210-118

Steel carrier rail; 35 x 15 mm; 2.3 mm thick; 2 m long; unslotted; according to EN 60715; silver-colored

1.1.4 Ferrule

1.1.4.1 Ferrule



Item No.: 216-413
 Ferrule; Sleeve for 25 mm² / AWG 4; un-insulated; electro-tin plated; electrolytic copper; gastight crimped; acc. to DIN 46228, Part 1/08.92; silver-colored

Item No.: 216-414
 Ferrule; Sleeve for 35 mm² / AWG 2; un-insulated; electro-tin plated; electrolytic copper; gastight crimped; acc. to DIN 46228, Part 1/08.92; silver-colored

Item No.: 216-424
 Ferrule; Sleeve for 35 mm² / AWG 2; un-insulated; electro-tin plated; electrolytic copper; gastight crimped; acc. to DIN 46228, Part 1/08.92; silver-colored

Item No.: 216-425
 Ferrule; Sleeve for 50 mm² / AWG 1; un-insulated; electro-tin plated; electrolytic copper; gastight crimped; acc. to DIN 46228, Part 1/08.92



Item No.: 216-435
 Ferrule; Sleeve for 50 mm² / AWG 1; un-insulated; electro-tin plated; electrolytic copper; gastight crimped; acc. to DIN 46228, Part 1/08.92

1.1.5 Installation

1.1.5.1 Mounting accessories



Item No.: 285-1179
 Fixing element; for 185 mm² high-current terminal blocks; orange

Item No.: 249-197
 Screwless end stop; 14 mm wide; for DIN-rail 35 x 15 and 35 x 7.5; gray

1.1.6 Jumper

1.1.6.1 Jumper



Item No.: 285-1171
 Jumper; insulated; gray

1.1.7 Marking

1.1.7.1 Marker



Item No.: 793-5501/000-006
 WMB marking card; as card; for terminal block width 5 - 17.5 mm; stretchable 5 - 5.2 mm; plain; snap-on type; blue



Item No.: 793-5501/000-014
 WMB marking card; as card; for terminal block width 5 - 17.5 mm; stretchable 5 - 5.2 mm; plain; snap-on type; brown



Item No.: 793-5501/000-007
 WMB marking card; as card; for terminal block width 5 - 17.5 mm; stretchable 5 - 5.2 mm; plain; snap-on type; gray



Item No.: 793-5501/000-023
 WMB marking card; as card; for terminal block width 5 - 17.5 mm; stretchable 5 - 5.2 mm; plain; snap-on type; green



Item No.: 793-5501/000-017
 WMB marking card; as card; for terminal block width 5 - 17.5 mm; stretchable 5 - 5.2 mm; plain; snap-on type; light green



Item No.: 793-5501/000-012
 WMB marking card; as card; for terminal block width 5 - 17.5 mm; stretchable 5 - 5.2 mm; plain; snap-on type; orange



Item No.: 793-5501/000-005
 WMB marking card; as card; for terminal block width 5 - 17.5 mm; stretchable 5 - 5.2 mm; plain; snap-on type; red



Item No.: 793-5501/000-024
 WMB marking card; as card; for terminal block width 5 - 17.5 mm; stretchable 5 - 5.2 mm; plain; snap-on type; violet



Item No.: 793-5501
 WMB marking card; as card; for terminal block width 5 - 17.5 mm; stretchable 5 - 5.2 mm; plain; snap-on type; white



Item No.: 793-5501/000-002
 WMB marking card; as card; for terminal block width 5 - 17.5 mm; stretchable 5 - 5.2 mm; plain; snap-on type; yellow



Item No.: 793-501/000-006
 WMB marking card; as card; not stretchable; plain; snap-on type; blue



Item No.: 793-501/000-007
 WMB marking card; as card; not stretchable; plain; snap-on type; gray



Item No.: 793-501/000-023
 WMB marking card; as card; not stretchable; plain; snap-on type; green



Item No.: 793-501/000-017
 WMB marking card; as card; not stretchable; plain; snap-on type; light green



Item No.: 793-501/000-012
 WMB marking card; as card; not stretchable; plain; snap-on type; orange



Item No.: 793-501/000-005
 WMB marking card; as card; not stretchable; plain; snap-on type; red

1.1.7.1 Marker



Item No.: 793-501/000-024

WMB marking card; as card; not stretchable; plain; snap-on type; violet

Item No.: 793-501

WMB marking card; as card; not stretchable; plain; snap-on type; white

Item No.: 793-501/000-002

WMB marking card; as card; not stretchable; plain; snap-on type; yellow

Item No.: 2009-115/000-006

WMB-Inline; for Smart Printer; 1500 pieces on roll; stretchable 5 - 5.2 mm; plain; snap-on type; blue



Item No.: 2009-115/000-007

WMB-Inline; for Smart Printer; 1500 pieces on roll; stretchable 5 - 5.2 mm; plain; snap-on type; gray

Item No.: 2009-115/000-023

WMB-Inline; for Smart Printer; 1500 pieces on roll; stretchable 5 - 5.2 mm; plain; snap-on type; green

Item No.: 2009-115/000-017

WMB-Inline; for Smart Printer; 1500 pieces on roll; stretchable 5 - 5.2 mm; plain; snap-on type; light green

Item No.: 2009-115/000-012

WMB-Inline; for Smart Printer; 1500 pieces on roll; stretchable 5 - 5.2 mm; plain; snap-on type; orange



Item No.: 2009-115/000-005

WMB-Inline; for Smart Printer; 1500 pieces on roll; stretchable 5 - 5.2 mm; plain; snap-on type; red

Item No.: 2009-115/000-024

WMB-Inline; for Smart Printer; 1500 pieces on roll; stretchable 5 - 5.2 mm; plain; snap-on type; violet

Item No.: 2009-115

WMB-Inline; for Smart Printer; 1500 pieces on roll; stretchable 5 - 5.2 mm; plain; snap-on type; white

Item No.: 2009-115/000-002

WMB-Inline; for Smart Printer; 1500 pieces on roll; stretchable 5 - 5.2 mm; plain; snap-on type; yellow

1.1.7.2 Marking strip



Item No.: 2009-110

Marking strips; for Smart Printer; on reel; not stretchable; plain; snap-on type; white

1.1.8 Power tap

1.1.8.1 Power tap



Item No.: 285-1175

Power tap; for 185 mm² high-current terminal blocks; 10,00 mm²; gray

1.1.9 Protective warning marker

1.1.9.1 Cover



Item No.: 285-1177

Protective warning marker; with high-voltage symbol, black; yellow

Item No.: 285-1176

Protective warning marker; yellow

1.1.10 Tool

1.1.10.1 Operating tool



Item No.: 285-172

Allen wrench; with a partially insulated shaft; green

Item No.: 285-173

Allen wrench; with a partially insulated shaft; with anti-rotation protection; green

Installation Notes

Installation

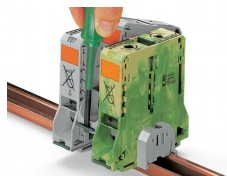

Snapping a terminal block onto DIN-rail (to the left or to the right).

Removing a terminal block from the assembly (to the left or to the right).

Conductor termination



For the optimal clamping force: Bend conductor Cut conductor to length (conductor end must be straight) Strip conductor



Always observe the on-unit printed strip length guide!

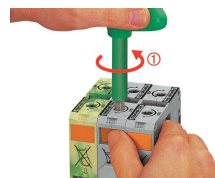

Conductor termination – step 1: Rotate the T-wrench counter-clockwise to the stop. Next, push in the orange locking tab. The clamp is locked open for hands-free wiring.

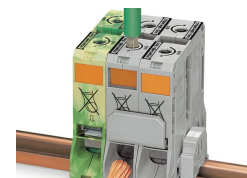

Conductor termination – step 2: Insert a stripped conductor into the clamping unit until it hits the backstop. Hold in this position.



Conductor termination – step 3: A short counter-clockwise rotation releases the tab. When unlocked, the T-wrench rotates clockwise, securely clamping the conductor.

Commoning

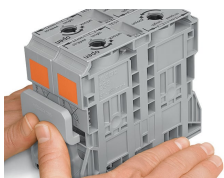

Commoning with an adjacent jumper: insert the jumper above the conductor entry hole – prior to conductor termination. The nominal cross-section remains unchanged.

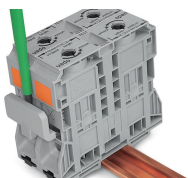

Removing jumper via operating tool.

Cover



Protective warning marker may indicate: Notice: Power is still on even after switching off the main switch!

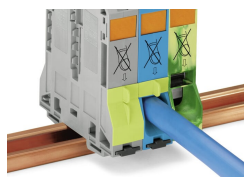

Yellow, detachable finger guards provide touch-proof safety by shielding jumper contact slots and/or unused conductor entries.

Power tap



Easily and consistently tap directly into the power supply. Insert the unwired tap before opening the clamping unit.

Security

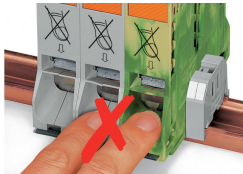

Risk of Injury!
Do not insert fingers in the conductor entry!

Testing

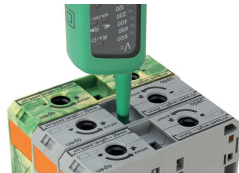

Testing via touch-proof 4 mm Ø test plugs (not available from WAGO, but offered by industry suppliers such as, Multi-Contact Deutschland GmbH).

Testing Voltage measurements can be performed, e.g., using a 2-pole voltage tester (206-707).

Marking

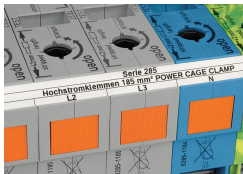

In addition to WMB markers, marking strips can be directly applied to 185 mm² (350 kcmil) high-current terminal blocks.