

Data sheet | Item number: 221-613

COMPACT Splicing Connector; for all conductor types; max. 6 mm²; 3-conductor; with levers; transparent housing; Surrounding air temperature: max 85°C (T85); 6,00 mm²; transparent

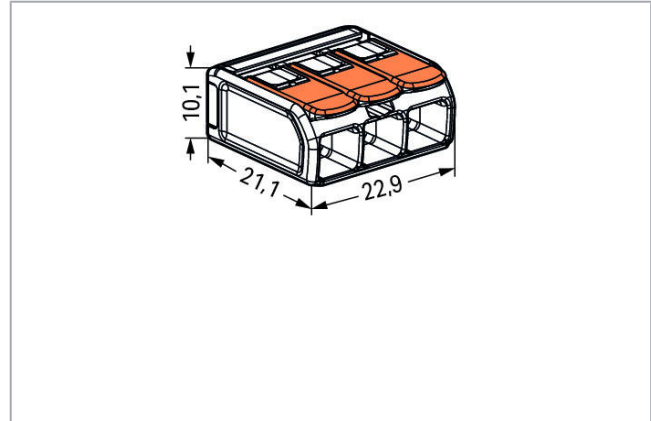

www.wago.com/221-613

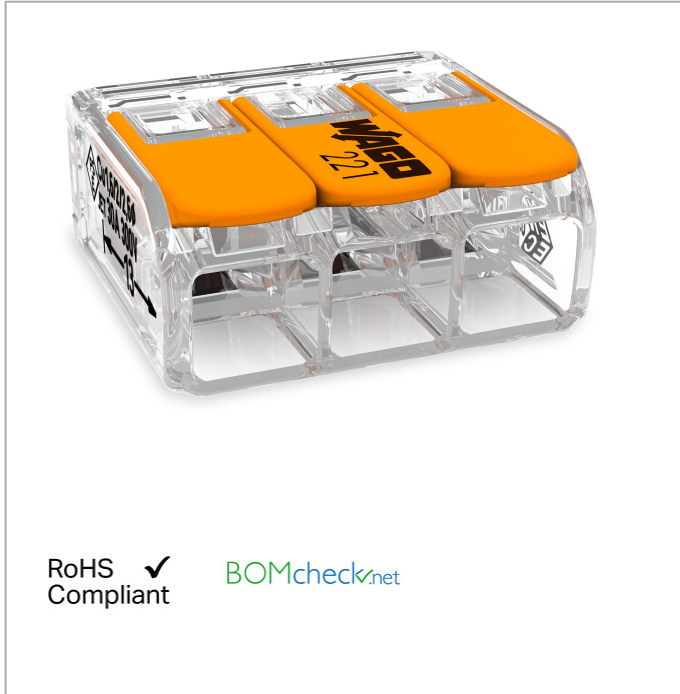

RoHS Compliant [BOMcheck.net](https://www.bomcheck.net)



Subject to changes. Please also observe the further product documentation!

WAGO Kontakttechnik GmbH & Co. KG
Hansastr. 27
32423 Minden
Phone: +49571 887-0 | Fax: +49571 887-169
Email: info.de@wago.com | Web: www.wago.com

Do you have any questions about our products?
We are always happy to take your call at 01788 568 008.



Item description

Your Benefits:

- Ease of use – pull the lever up, insert a conductor and push the lever back down
- Available as 2-, 3- and 5-wire connectors
- Easily terminate conductors from 0.5 to 6 mm²
- Connection of all conductor types
- Time savings for installers and device manufacturers
- Quickly install devices with higher levels of power consumption
- Safely install long cable runs with larger conductor cross sections
- Mounting carrier for installation conforms to standards
- Custom carriers are possible

Safety information 1:

in grounded power lines

Data

Electrical data

Ratings per IEC/EN 60664-1

Ratings per	EN 60664
Nominal voltage (II/2)	450 V
Rated surge voltage (II/2)	4 kV
Rated current	41 A
Legend (ratings)	(II / 2) ≙ Overvoltage category II / Pollution degree 2

Ratings per UL 1059

Approvals per	UL 486C
Rated voltage UL (Use Group C)	600 V
Rated current UL (Use Group C)	30 A

Connection data

Connection technology	CAGE CLAMP®
Actuation type	Lever
Connectable conductor materials	Copper
Nominal cross-section	6 mm ²
Solid conductor	0.5 ... 6 mm ² / 20 ... 10 AWG

Subject to changes. Please also observe the further product documentation!

WAGO Kontakttechnik GmbH & Co. KG
Hansastr. 27
32423 Minden
Phone: +49571 887-0 | Fax: +49571 887-169
Email: info.de@wago.com | Web: www.wago.com

Do you have any questions about our products?
We are always happy to take your call at 01788 568 008.



Stranded conductor	0.5 ... 6 mm ² / 20 ... 10 AWG
Fine-stranded conductor	0.5 ... 6 mm ² / 20 ... 10 AWG
Strip length	12 ... 14 mm / 0.47 ... 0.55 inch
Total number of connection points	3
Total number of potentials	1
Wiring type	Side-entry wiring

Physical data

Width	22.9 mm / 0.902 inch
Height	10.1 mm / 0.398 inch
Depth	21.1 mm / 0.831 inch

Material Data

Color	transparent
Flammability class per UL94	V2
Color of actuator	orange
Weight	4 g

Environmental Requirements

Surrounding air temperature (operation)	85 ... 85 °C
Continuous operating temperature	105 ... 105 °C
Temperature marking per EN 60998	T85

Commercial data

Packaging type	BOX
Country of origin	CH
GTIN	4055143715416
Customs tariff number	85369010000

Approvals / Certificates

Country specific Approvals



Logo	Approval	Additional Approval Text	Certificate name
	KEMA/KEUR DEKRA Certification B.V.	EN 60998	71- 105677

Subject to changes. Please also observe the further product documentation!



WAGO Kontakttechnik GmbH & Co. KG
Hansastr. 27
32423 Minden
Phone: +49571 887-0 | Fax: +49571 887-169
Email: info.de@wago.com | Web: www.wago.com

Do you have any questions about our products?
We are always happy to take your call at 01788 568 008.

Ship Approvals

Logo	Approval	Additional Approval Text	Certificate name
	ABS American Bureau of Shipping	EN 60998	18-HG1755093-PDA
	DNV GL Det Norske Veritas, Germanischer Lloyd	EN 60998	TAE000015T
	LR Lloyds Register	EN 60998	04/20013 (E8)



UL-Approvals

Logo	Approval	Additional Approval Text	Certificate name
	UL Underwriters Laboratories Inc.	UL 467	E201573
	UL Underwriters Laboratories Inc.	UL 486C	E69654

Counterpart

Compatible products

Mounting adapter

	Item no.: 221-510 Mounting carrier; 221 Series - 6 mm ² ; for DIN-35 rail mounting/screw mounting; orange	www.wago.com/221-510
	Item no.: 221-510/000-006 Mounting carrier; 221 Series - 6 mm ² ; for DIN-35 rail mounting/screw mounting; blue	www.wago.com/221-510/000-006

Subject to changes. Please also observe the further product documentation!



Item no.: 221-510/000-053

Mounting carrier; 221 Series - 6 mm²; for DIN-35 rail mounting/screw mounting; dark gray-yellow

www.wago.com/221-510/000-053

Downloads

Documentation

Bid Text

221-613 GAEB X81 - Datei	Feb 19, 2019	xml 3.6 kB	Download
-----------------------------	--------------	---------------	----------

221-613 GAEB docx - Datei	Jan 23, 2019	docx 15.4 kB	Download
------------------------------	--------------	-----------------	----------

Additional Information

Technical explanations	Apr 3, 2019	pdf 2.1 MB	Download
------------------------	-------------	---------------	----------

CAD/CAE-Data

CAD data

2D/3D Models 221-613		URL	Download
----------------------	--	-----	----------

CAE data

ZUKEN Portal 221-613		URL	Download
----------------------	--	-----	----------

Installation Notes

Conductor termination

Subject to changes. Please also observe the further product documentation!

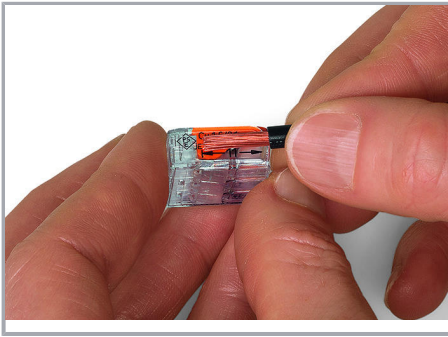

Strip conductor to 11 mm (0.43 inch).

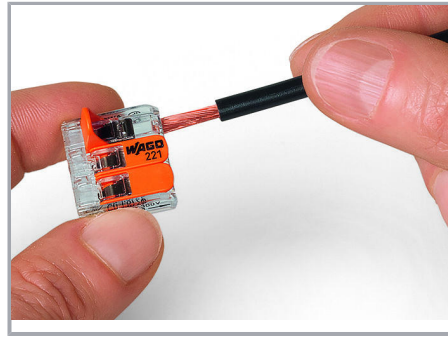

Termination: Lift the lever to open the clamping unit and insert a stripped conductor.

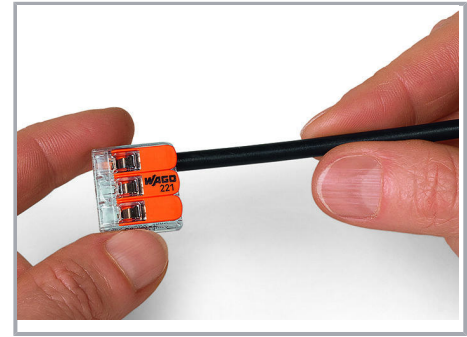

Then, lower the lever to close the clamp.

Application

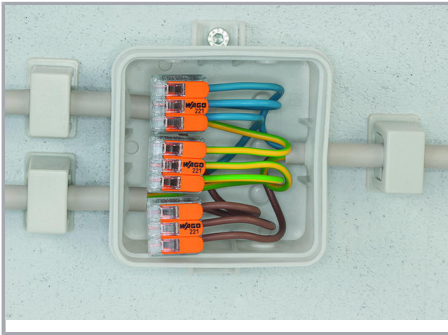

Wiring fine-stranded conductors in a junction box.

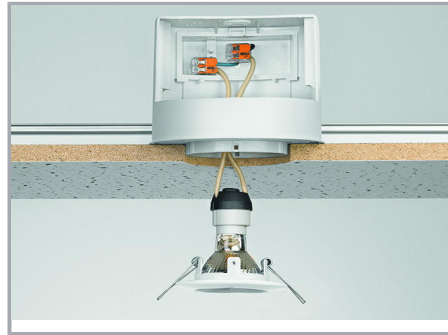

Custom low-voltage lighting system



Lighting distribution in ceiling canopy



Pendant light connection in suspended ceilings

Subject to changes. Please also observe the further product documentation!

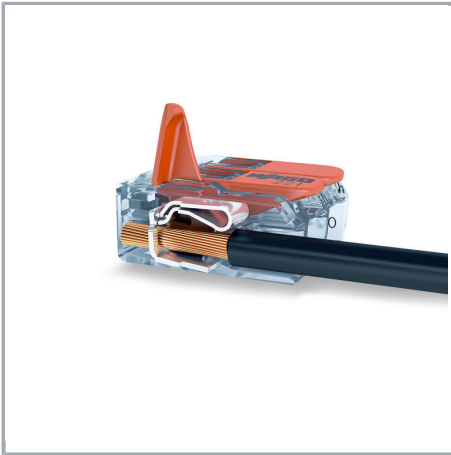

COMPACT Splicing Connectors for All
Conductor Types, 4 mm² (12 AWG), 221
Series

Subject to changes. Please also observe the further product documentation!