

PC 175/60 HG



Sample image

Order symbol: PC 175/60 HG

Product nbr: 6011319

UL Code: 6411319

UL Name: UL PC 175/60 HG

Description: Enclosure. PC

Remarks: Opaque cover

Including: Base with TPE gasket. screws for mounting plate/DIN-rail and cover with polyamide cover screws.

EAN: 6418074022219

El. number:

- Finland: 3420361
- Denmark: 8212022205
- Sweden: 2535563

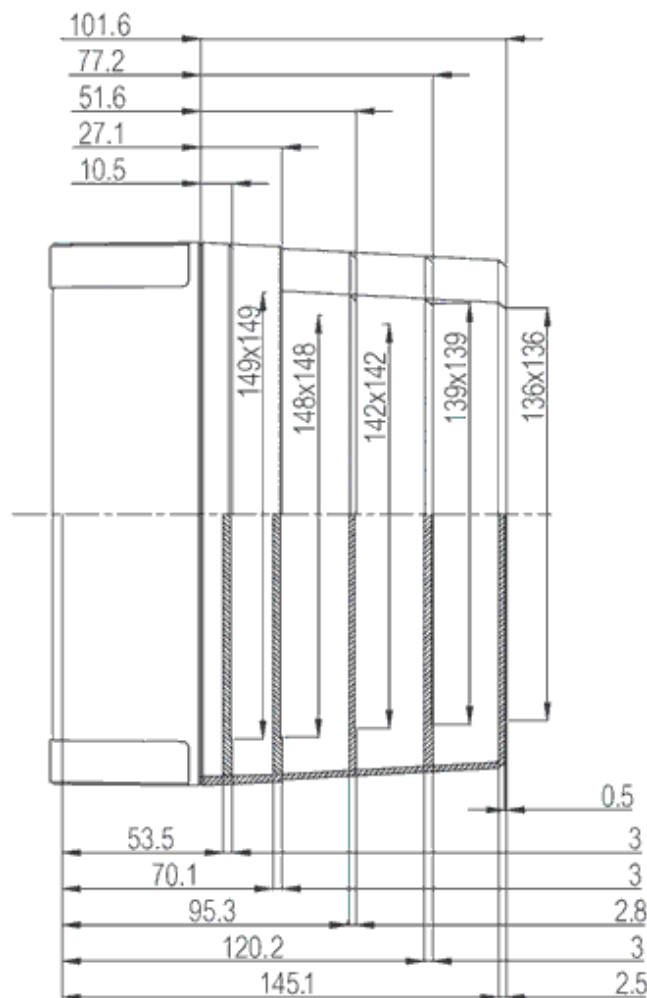
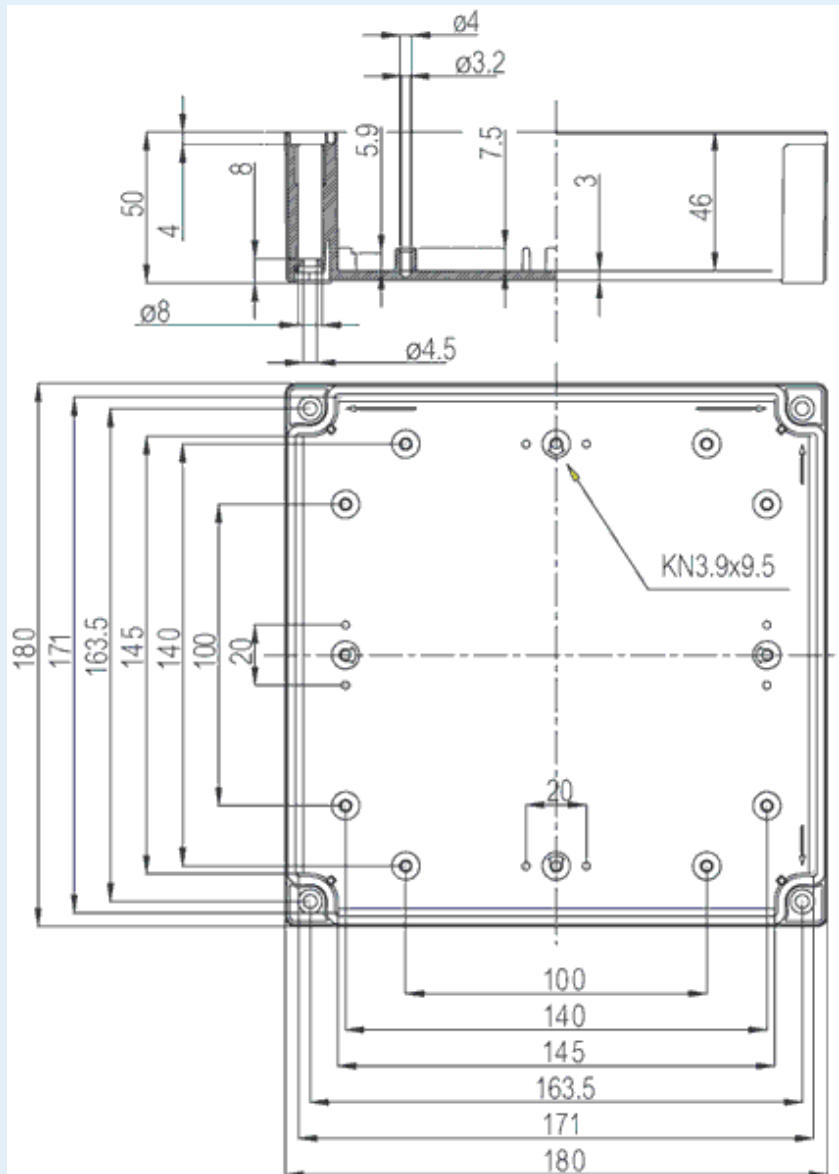

Dimensions:

	Height	Width	Depth
mm:	180	180	60
inch:	7.09	7.09	2.36

Materials:

Material:	Polycarbonate
Base colour:	RAL 7035 -light grey
Cover colour:	RAL 7035 -light grey
Gasket material:	Polyurethane

Temperatures:

Temperature °C (short term)::	-40 ... 120
Temperature °C (continuous):	-40 ... 80
Temperature °F (short term):	-40 ... 250
Temperature °F (continuous):	-40 ... 175

Accessories:

MIV 175	Back Panel (Galvanized steel). for enclosures: (148 x 148 x 1)
FP A 175/180	Front panel (Aluminum). for enclosures: (170 x 162 x 1)
HFP 180	Front panel hinge series
MIN 15	DIN-15 Mounting rail. for enclosures: (150 x 15 x 1)
MIV 15	DIN-35 Mounting rail. for enclosures: (150 x 35 x 1)
FP 22046	Mounting foot kit (4 pcs)

Rating:

Ingress protection (EN 60529):	IP66; IP67;
Impact Resistance (EN 62262):	IK08;
Electrical insulation:	Totally insulated
Halogen free (DIN/VDE 0472, Part 815):	1
UV resistance:	UL 508
Flammability Rating:	UL 746C 5"

Glow Wire Test (IEC 695-2-1) °C:

960 °C

NEMA Class

Certificates:

Certificate FI 40847