



## Main

Range	TeSys
Product name	TeSys GV3
Device short name	GV3L
Device application	Motor
Poles description	3P
Network type	AC
Utilisation category	Category A conforming to IEC 60947-2 AC-3 conforming to IEC 60947-4-1
Network frequency	50/60 Hz
Breaking capacity	100 KA Icu at 230/240 V AC 50/60 Hz 100 KA Icu at 400/415 V AC 50/60 Hz 50 KA Icu at 440 V AC 50/60 Hz 12 KA Icu at 500 V AC 50/60 Hz 6 KA Icu at 690 V AC 50/60 Hz
[Ics] rated service short-circuit breaking capacity	100 % at 230/240 V AC 50/60 Hz 100 % at 400/415 V AC 50/60 Hz 100 % at 440 V AC 50/60 Hz 50 % at 500 V AC 50/60 Hz 50 % at 690 V AC 50/60 Hz
Trip unit technology	Magnetic
Magnetic tripping current	350 A

## Complementary

Fixing mode	35 mm symmetrical DIN rail: clipped Panel: screwed (with 3 x M4 screws)
Operating position	Any position
Motor power kW	11 KW at 400/415 V AC 50/60 Hz 15 KW at 500 V AC 50/60 Hz 18.5 KW at 690 V AC 50/60 Hz
Control type	Rotary knob
[Ue] rated operational voltage	690 V AC 50/60 Hz conforming to IEC 60947-2
[Ui] rated insulation voltage	690 V AC 50/60 Hz conforming to IEC 60947-2
[Uimp] rated impulse withstand voltage	6 KV IEC 60947-2
Mechanical durability	50000 Cycles
Electrical durability	50000 Cycles for AC-3 at 415 V
Maximum operating rate	25 Cyc/H

Connections - terminals	EverLink BTR screw connectors 1 cable(s) 1...35 mm <sup>2</sup> solid EverLink BTR screw connectors 2 cable(s) 1...25 mm <sup>2</sup> solid EverLink BTR screw connectors 1 cable(s) 1...35 mm <sup>2</sup> flexible without cable end EverLink BTR screw connectors 2 cable(s) 1...25 mm <sup>2</sup> flexible without cable end EverLink BTR screw connectors 1 cable(s) 1...35 mm <sup>2</sup> flexible with cable end EverLink BTR screw connectors 2 cable(s) 1...25 mm <sup>2</sup> flexible with cable end
Tightening torque	5 N.M on EverLink BTR screw connectors for cable 25 mm <sup>2</sup> 8 N.M on EverLink BTR screw connectors for cable 35 mm <sup>2</sup>
Mechanical robustness	Shocks: 15 Gn for 11 ms closed conforming to IEC 60068-2-27 Shocks: 30 Gn for 11 ms opened conforming to IEC 60068-2-27 Vibrations: 4 Gn, 5...300 Hz conforming to IEC 60068-2-6
Suitability for isolation	Yes conforming to IEC 60947-1
Height	132 Mm
Width	55 Mm
Depth	136 Mm
Net weight	0.96 Kg





## Environment

Standards	EN/IEC 60947-2 EN/IEC 60947-4-1 CSA C22.2 No 60947-4-1 UL 60947-4-1
Product certifications	IECEE CB Scheme UL CSA CCC EAC ABS LROS (Lloyds register of shipping) DNV-GL BV
Protective treatment	TH
IP degree of protection	IP20 conforming to IEC 60529
IK degree of protection	IK09
Ambient air temperature for operation	-20...60 °C
Ambient air temperature for storage	-40...80 °C
Fire resistance	960 °C conforming to IEC 60695-2-1
Operating altitude	0...3000 m

## Packing Units

Unit Type of Package 1	PCE
Number of Units in Package 1	1
Package 1 Weight	996 G
Package 1 Height	6.5 Cm
Package 1 width	14.5 Cm
Package 1 Length	16 Cm
Unit Type of Package 2	P06
Number of Units in Package 2	60
Package 2 Weight	72.76 Kg
Package 2 Height	80 Cm
Package 2 width	80 Cm
Package 2 Length	60 Cm

## Offer Sustainability

Sustainable offer status	Green Premium product
REACH Regulation	 <a href="#">REACH Declaration</a>
EU RoHS Directive	Compliant  <a href="#">EU RoHS Declaration</a>
Mercury free	Yes
RoHS exemption information	 <a href="#">Yes</a>
China RoHS Regulation	 <a href="#">China RoHS Declaration</a>

---

Environmental Disclosure	<a href="#">Product Environmental Profile</a>
WEEE	The product must be disposed on European Union markets following specific waste collection and never end up in rubbish bins

---

**Contractual warranty**

Warranty	18 months
----------	-----------

---

Tripping Curves for GV3L Combined with Thermal Overload Relay LRD33

Average Operating time at 20 °C without Prior Current Flow

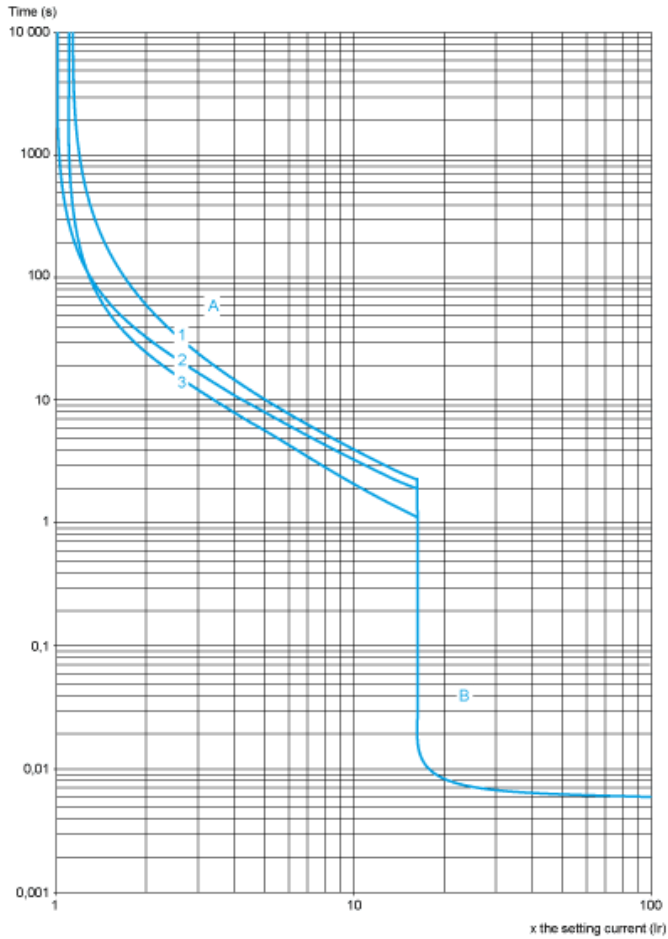

- 1 3 poles from cold state
- 2 2 poles from cold state
- 3 3 poles from hot state
- A Thermal overload relay protection zone
- B GV3L protection zone

Current Limitation on Short-Circuit for GV3L (3-Phase 400/415 V)

Dynamic Stress

$I_{peak} = f(\text{prospective } I_{sc}) \text{ at } 1.05 U_e = 435 \text{ V}$

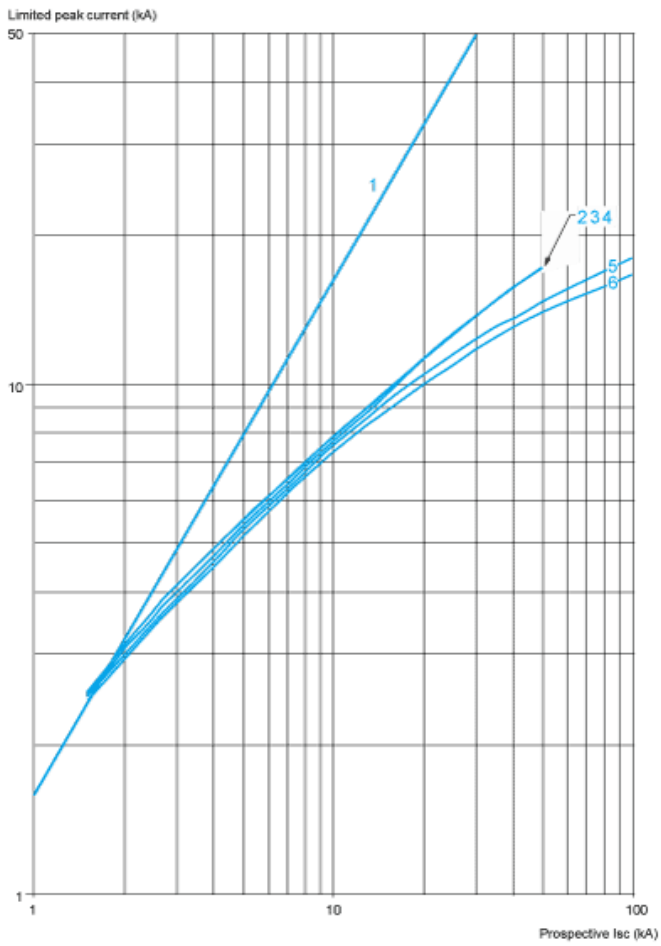

- 1 Maximum peak current
- 2 GV3L80 - GV3L73 - GV3L65
- 3 GV3L50
- 4 GV3L40
- 5 GV3L32
- 6 GV3L25

### Thermal Limit on Short-Circuit for GV3L

Thermal Limit in  $A^2s$

Sum of  $I^2dt = f$  (prospective Isc) at  $1.05 U_e = 435 V$

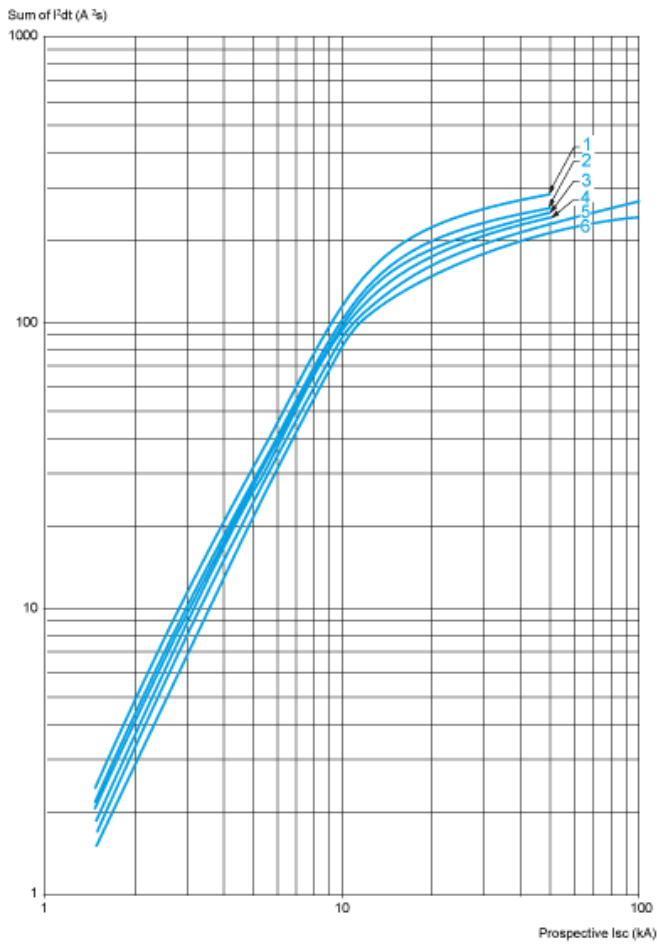

- 1 GV3L73 - GV3L80
- 2 GV3L65
- 3 GV3L50
- 4 GV3L40
- 5 GV3L32
- 6 GV3L25

GV3L, GV3P

Dimensions

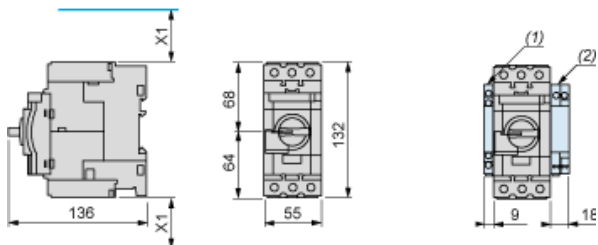

- (1) Blocks GVAN.., GVAD.. and GVAM11.
- (2) Blocks GV3AU.. and GV3AS..

X1 = Electrical clearance (ISC max) 40 mm for  $U_e \leq 500$  V, 50 mm for  $U_e \leq 690$  V

NOTE: Leave a space of 9 mm between 2 circuit breakers: either an empty space or side-mounting add-on contact blocks. Side by side mounting is possible up to 40 °C.

Mounting with Tesys contactor LC1D40A...D80A and relay LR3D313...380 <sup>(1) (2) (3)</sup>

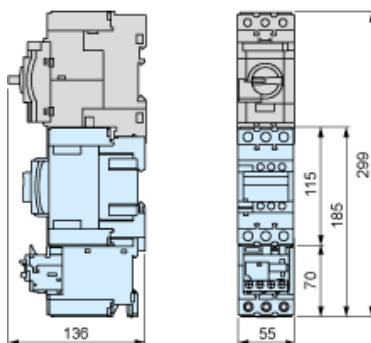

- (1) Mountings with c.b. up to GV3L73, GV3P73.
- (2) For GV3L80, GV3P80 use cable between components for dissipating heat. Consult online datasheets for values.
- (3) S-shape busbar system suitable up to 73 A.

Side by side mounting with Tesys contactor LC1D40A...D73A (S-shape busbar system GV3S<sup>(1)</sup>)

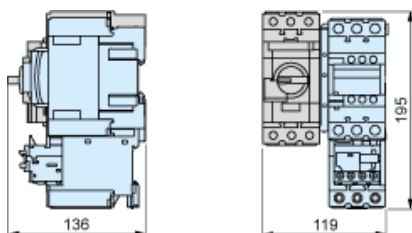

- (1) Mountings with c.b. up to GV3L73, GV3P73.

Mounting on Rail AM1 DE200 or AM1 ED201

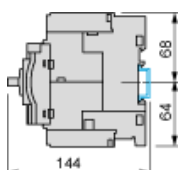

Panel Mounting, using M4 Screws

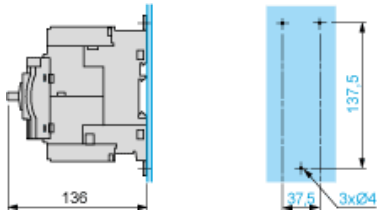

Mounting on Pre-Slotted Plate AM1 PA

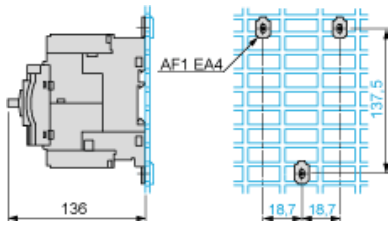

Mounting of External Operator GV3APN01, GV3APN02 or GV3APN04 for Motor Circuit Breakers GV3L

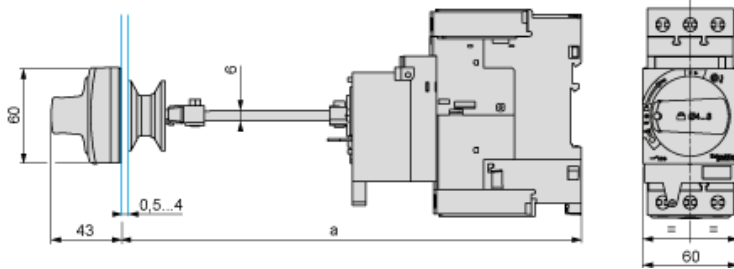

Door cut-out

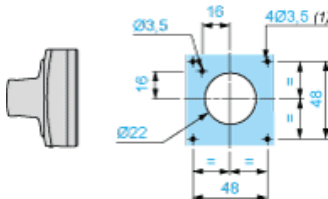

(1) For IP65 only.

Mounting of External Operator GVAPH03 for Motor Circuit Breakers GV3L

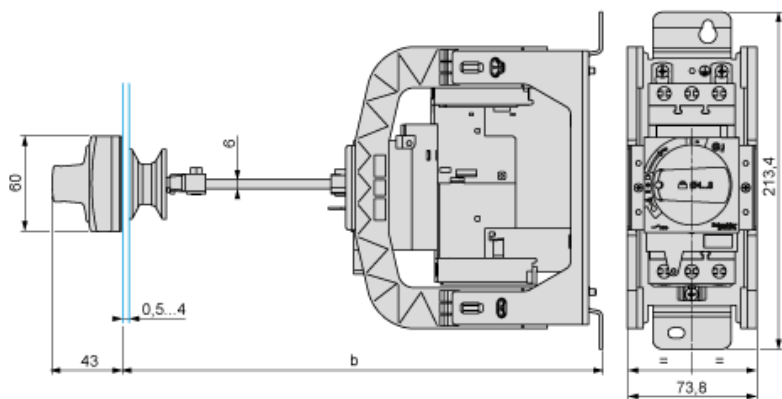

	b	
	Minimum	Maximum
GV3APN.. + GVAPH03	200	300
GV3APN.. + GVAPH03 + GVAPK12	300	492

Door cut-out

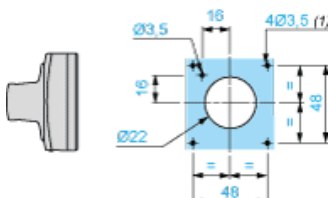

(1) For IP65 only.



GV3L••

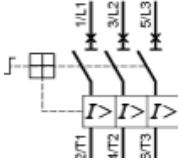

Product Life Status : **Commercialised**