

Data sheet | Item number: 750-891

Controller Modbus TCP; 4th generation; 2 x ETHERNET; light gray

www.wago.com/750-891

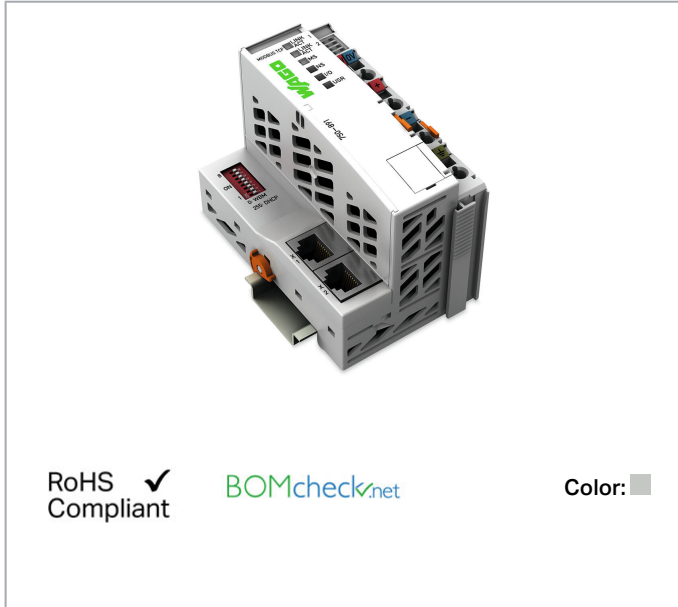

RoHS Compliant ✓

BOMcheck.net

Color: ■

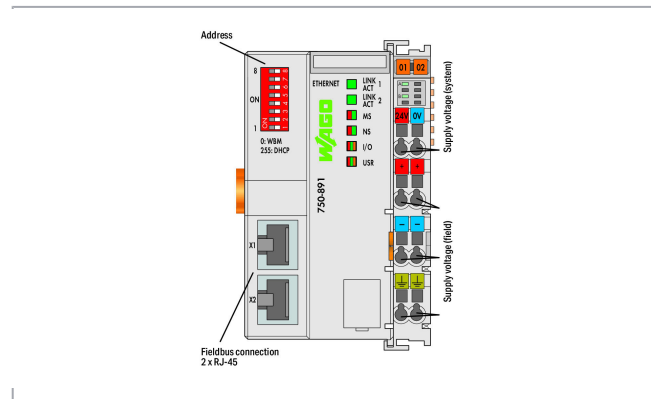
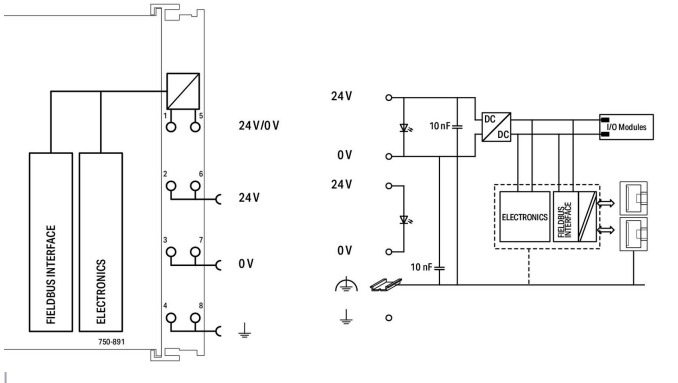
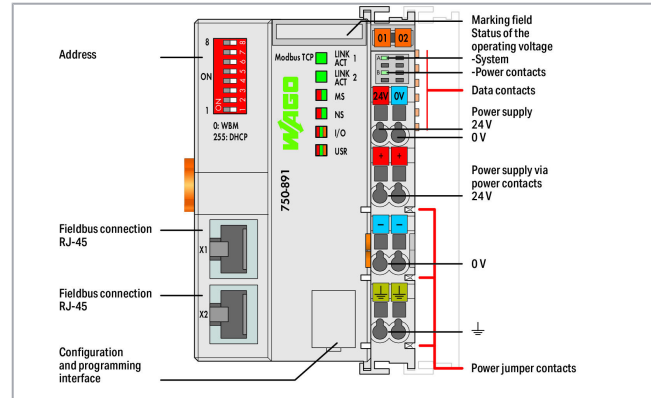

Item description

The Modbus TCP Controller can be used as a programmable controller within ETHERNET networks in conjunction with the WAGO I/O System.

The controller detects all connected I/O modules and creates a local process image. This process image may include a mixed arrangement of analog (word-by-word data transfer) and digital (bit-by-bit data transfer) modules.

Two ETHERNET interfaces and an integrated switch allow the fieldbus to be wired in a line topology, eliminating the need for additional network devices, such as switches or hubs. Both interfaces support autonegotiation and Auto-MDI(X).

The DIP switch configures the last byte of the IP address and may be used for IP address assignment.

Subject to changes. Please also observe the further product documentation!

WAGO Kontakttechnik GmbH & Co. KG
Hansastr. 27
32423 Minden
Phone: +49571 887-0 | Fax: +49571 887-169
Email: info.de@wago.com | Web: www.wago.com

Do you have any questions about our products?
We are always happy to take your call at 01788 568 008.



The controller is designed for fieldbus communication in Modbus® networks. It also supports a wide variety of standard ETHERNET protocols (e.g., HTTP(S), BootP, DHCP, DNS, SNTP, (S)FTP, SNMP).

An integrated Webserver provides user configuration options, while displaying the controller's status information.

The IEC 61131-3 programmable controller is multitasking-capable and features a capacitor-backed RTC.

Data

Technical Data

Communication	Modbus (TCP, UDP)
ETHERNET protocols	HTTP(S) BootP DHCP DNS SNTP (S)FTP SNMP
Visualization	Web Visu
CPU	32 bits
Programming languages per IEC 61131-3	Instruction List (IL) Ladder Diagram (LD) Function Block Diagram (FBD), Continuous Function Chart (CFC) Structured Text (ST) Sequential Function Chart (SFC)
Programming environment	WAGO-I/O-PRO V2.3 (based on CODESYS V2.3)
Configuration options	WAGO-I/O-CHECK Web-based management CODESYS Library
Baud rate (communication/fieldbus 1)	10/100 Mbit/s
Baud rate	10/100 Mbit/s
Transmission medium (communication/fieldbus)	Twisted Pair S-UTP; 100 Ω; Cat. 5; 100 m maximum cable length
Transmission performance	Class D per EN 50173
Program memory	4 MB
Data memory	4 MB
Non-volatile software memory	32 Kbytes
Number of modules per node (max.)	250
Number of modules without a bus extension (max.)	64
Input and output (fieldbus) process image (max.)	1020 Worte/1020 Worte
Indicators	LED (LINK/ACT) green: Network connection via ports 1 ... 2; LED (MS, NS) red/green: Status of node, network; LED (I/O, USR) red /green/orange: Local data bus status, status programmable by user; LED (A, B) green: System power supply status, field supply

Subject to changes. Please also observe the further product documentation!



Supply voltage (system)	DC 24 V (-25 ... +30 %); via pluggable connector (CAGE CLAMP® connection)
Input current (typ.) at nominal load (24 V)	500 mA
Power supply efficiency (typ.) at nominal load (24 V)	90 %
Power consumption (5 V system supply)	390 mA
Total current (system supply)	1,700 mA
Supply voltage (field)	DC 24 V (-25 ... +30 %); via power jumper contacts
Current carrying capacity (power jumper contacts)	10 A
Number of outgoing power jumper contacts	3
Isolation	500 V system/field

Connection data

Connection technology: communication/fieldbus	Modbus TCP/UDP: 2 x RJ-45; 2 x RJ-45
Connection technology: system supply	2 x CAGE CLAMP®
Connection technology: field supply	6 x CAGE CLAMP®
Connection type (1)	System/field supply
Solid conductor	0.08 ... 2.5 mm ² / 28 ... 14 AWG
Fine-stranded conductor	0.08 ... 2.5 mm ² / 28 ... 14 AWG
Strip length	8 ... 9 mm / 0.31 ... 0.35 inch
Connection technology: Device configuration	1 x Male connector; 4-pole

Physical data

Width	61.5 mm / 2.421 inch
Height	100 mm / 3.937 inch
Depth	71.9 mm / 2.831 inch
Depth from upper edge of DIN-rail	64.7 mm / 2.547 inch

Mechanical data

Weight	149.9 g
Color	light gray
Housing material	Polycarbonate; Polyamide 6.6
Conformity marking	CE

Environmental Requirements

Surrounding air temperature (operation)	0 ... 55 °C
Surrounding air temperature (storage)	-40 ... 85 °C

Subject to changes. Please also observe the further product documentation!

WAGO Kontakttechnik GmbH & Co. KG
 Hansastr. 27
 32423 Minden
 Phone: +49571 887-0 | Fax: +49571 887-169
 Email: info.de@wago.com | Web: www.wago.com

Do you have any questions about our products?
 We are always happy to take your call at 01788 568 008.



Protection type	IP20
Pollution degree (5)	2 per IEC 61131-2
Operating altitude	without temperature derating: 0 ... 2000 m; with temperature derating: 2000 ... 5000 m (0.5 K/100 m); 5000 m (max.)
Relative humidity (without condensation)	95 %
Mounting position	any
Mounting type	DIN-35 rail
Vibration resistance	4g per IEC 60068-2-6
Shock resistance	15g per IEC 60068-2-27
EMC immunity to interference	per EN 61000-6-2, marine applications
EMC emission of interference	per EN 61000-6-3, marine applications
Exposure to pollutants	Per IEC 60068-2-42 and IEC 60068-2-43
Permissible H ₂ S contaminant concentration at a relative humidity 75 %	10 ppm
Permissible SO ₂ contaminant concentration at a relative humidity 75 %	25 ppm

Commercial data

Packaging type	BOX
Country of origin	DE
GTIN	4055143821513
Customs tariff number	85371091990

Approvals / Certificates

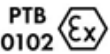
Ex-Approvals





Logo	Approval	Additional Approval Text	Certificate name
	ATEX TUEV Nord Cert GmbH	EN 60079	TUEV_14_ATEX_148929_X
 Ex nA IIC T4 Gc	CCCEX CQST/CNEx	CNCA-C23-01	2020312310000213
	IECEX TUEV Nord Cert GmbH	IEC 60079-0	IECEX_TUN_14.0035_X

Subject to changes. Please also observe the further product documentation!

Country specific Approvals



Logo	Approval	Additional Approval Text	Certificate name
	KC National Radio Research Agency	Article 58-2, Clause 3	MSIP- REM-W43- PFC750

Ship Approvals

Logo	Approval	Additional Approval Text	Certificate name
	ABS American Bureau of Shipping	-	19- HG1821926
	DNV GL Det Norske Veritas, Germanischer Lloyd	-	TAA0000194
	LR Lloyds Register	-	02/20026 (E6)
	PRS Polski Rejestr Statków	-	TE/2236 /880590/19
	RINA RINA Germany GmbH	-	ELE066419XG

Compatible products

Marking accessories

	Item no.: 248-501 Miniature WSB Quick marking system; plain; Marker width 5 mm; 10 strips with 10 markers per card	www.wago.com/248-501
	Item no.: 248-501/000-002 Mini-WSB marking card; as card; not stretchable; plain; snap-on type; yellow	www.wago.com/248-501/000-002

Subject to changes. Please also observe the further product documentation!



Item no.: 248-501/000-005
Mini-WSB marking card; as card; not stretchable; plain; snap-on type; red

www.wago.com/248-501/000-005



Item no.: 248-501/000-006
Mini-WSB marking card; as card; not stretchable; plain; snap-on type; blue

www.wago.com/248-501/000-006



Item no.: 248-501/000-007
Mini-WSB marking card; as card; not stretchable; plain; snap-on type; gray

www.wago.com/248-501/000-007



Item no.: 248-501/000-012
Mini-WSB marking card; as card; not stretchable; plain; snap-on type; orange

www.wago.com/248-501/000-012



Item no.: 248-501/000-017
Mini-WSB marking card; as card; not stretchable; plain; snap-on type; light green

www.wago.com/248-501/000-017



Item no.: 248-501/000-023
Mini-WSB marking card; as card; not stretchable; plain; snap-on type; green

www.wago.com/248-501/000-023



Item no.: 248-501/000-024
Mini-WSB marking card; as card; not stretchable; plain; snap-on type; violet

www.wago.com/248-501/000-024



Item no.: 750-100
Marker card; as a DIN A4 sheet; plain; white

www.wago.com/750-100



Item no.: 750-103
Group marker carrier; transparent

www.wago.com/750-103



Item no.: 750-106
Group marker carrier; transparent

www.wago.com/750-106

wiring and connectors



Item no.: 750-975
ETHERNET RJ-45 connector, IP20; ETHERNET 10/100 Mbit/s; for field assembly; light gray

www.wago.com/750-975



Item no.: 750-977/000-011
Connector ETHERNET; RJ-45; Cat. 6A; straight; Code T568A; AWG 22

www.wago.com/750-977/000-011



Item no.: 750-977/000-012
Connector ETHERNET; RJ-45; Cat. 6A; straight; Code T568B; AWG 22

www.wago.com/750-977/000-012



Item no.: 750-977/000-021
Connector ETHERNET; RJ-45; Cat. 6A; straight; Code T568A; AWG 24

www.wago.com/750-977/000-021

Subject to changes. Please also observe the further product documentation!



Item no.: 750-977/000-022
Connector ETHERNET; RJ-45; Cat. 6A; straight; Code T568B; AWG 24

www.wago.com/750-977/000-022



Item no.: 750-978/000-011
Connector ETHERNET; RJ-45; Cat. 6A; straight; Code T568A; AWG 22; Strain relief

www.wago.com/750-978/000-011



Item no.: 750-978/000-012
Connector ETHERNET; RJ-45; Cat. 6A; straight; Code T568B; AWG 22; Strain relief

www.wago.com/750-978/000-012



Item no.: 750-978/000-021
Connector ETHERNET; RJ-45; Cat. 6A; straight; Code T568A; AWG 24; Strain relief

www.wago.com/750-978/000-021



Item no.: 750-978/000-022
Connector ETHERNET; RJ-45; Cat. 6A; straight; Code T568B; AWG 24; Strain relief

www.wago.com/750-978/000-022



Item no.: 750-979/000-011
Connector ETHERNET; RJ-45; Cat. 6A; angled; Code T568A; AWG 22; Strain relief

www.wago.com/750-979/000-011



Item no.: 750-979/000-012
Connector ETHERNET; RJ-45; Cat. 6A; angled; Code T568B; AWG 22; Strain relief

www.wago.com/750-979/000-012



Item no.: 750-979/000-021
Connector ETHERNET; RJ-45; Cat. 6A; angled; Code T568A; AWG 24; Strain relief

www.wago.com/750-979/000-021



Item no.: 750-979/000-022
Connector ETHERNET; RJ-45; Cat. 6A; angled; Code T568B; AWG 24; Strain relief

www.wago.com/750-979/000-022

General accessories



Item no.: 750-921
Bluetooth® Adapter; light gray

www.wago.com/750-921



Item no.: 750-923
Configuration cable; USB connector; Length: 2.5 m; black

www.wago.com/750-923



Item no.: 750-923/000-001
Configuration cable; USB connector; Length: 5 m

www.wago.com/750-923/000-001

shield connection



Item no.: 790-108
Shield clamping saddle; 11 mm wide; diameter of compatible conductor; 3 ... 8 mm

















www.wago.com/790-108







Item no.: 790-116
Shield clamping saddle; 19 mm wide; diameter of compatible conductor; 7 ... 16 mm

www.wago.com/790-116

Subject to changes. Please also observe the further product documentation!

	Item no.: 790-124 Shield clamping saddle; 27 mm wide; diameter of compatible conductor; 6 ... 24 mm	www.wago.com/790-124
	Item no.: 790-140 Shield clamping saddle; diameter of compatible conductor	www.wago.com/790-140
	Item no.: 790-208 Shield clamping saddle; 12.4 mm wide; 3 ... 8 mm	www.wago.com/790-208
	Item no.: 790-216 Shield clamping saddle; 21.8 mm wide; 6 ... 16 mm	www.wago.com/790-216
	Item no.: 790-220 Shield clamping saddle; 30 mm wide; 6 ... 20 mm	www.wago.com/790-220
software		
	Item no.: 759-333 WAGO-I/O-PRO	www.wago.com/759-333
	Item no.: 759-333/000-923 WAGO-I/O-PRO; USB-Set	www.wago.com/759-333/000-923
	Item no.: 759-911 WAGO-I/O-PRO; CD	www.wago.com/759-911
Carrier rail		
	Item no.: 210-112 Steel carrier rail; 35 x 7.5 mm; 1 mm thick; 2 m long; slotted; according to EN 60715; "Hole width 25 mm; silver-colored	www.wago.com/210-112
	Item no.: 210-113 Steel carrier rail; 35 x 7.5 mm; 1 mm thick; 2 m long; unslotted; according to EN 60715; silver-colored	www.wago.com/210-113
	Item no.: 210-114 Steel carrier rail; 35 x 15 mm; 1.5 mm thick; 2 m long; unslotted; similar to EN 60715; silver-colored	www.wago.com/210-114
	Item no.: 210-115 Steel carrier rail; 35 x 7.5 mm; 1 mm thick; 2 m long; slotted; according to EN 60715; "Hole width 18 mm; silver-colored	www.wago.com/210-115
	Item no.: 210-118 Steel carrier rail; 35 x 15 mm; 2.3 mm thick; 2 m long; unslotted; according to EN 60715; silver-colored	www.wago.com/210-118
	Item no.: 210-196 Aluminum carrier rail; 35 x 8.2 mm; 1.6 mm thick; 2 m long; unslotted; similar to EN 60715; silver-colored	www.wago.com/210-196
	Item no.: 210-197 Steel carrier rail; 35 x 15 mm; 1.5 mm thick; 2 m long; slotted; similar to EN 60715; silver-colored	www.wago.com/210-197
	Item no.: 210-198 Copper carrier rail; 35 x 15 mm; 2.3 mm thick; 2 m long; unslotted; according to EN 60715; copper-colored	www.wago.com/210-198

Subject to changes. Please also observe the further product documentation!

	Item no.: 210-504 Steel carrier rail; 35 x 7.5 mm; 1 mm thick; 2 m long; slotted; galvanized; according to EN 60715	www.wago.com/210-504
	Item no.: 210-505 Steel carrier rail; 35 x 7.5 mm; 1 mm thick; 2 m long; unslotted; galvanized; according to EN 60715; silver-colored	www.wago.com/210-505
	Item no.: 210-506 Steel carrier rail; 35 x 15 mm; 1.5 mm thick; 2 m long; unslotted; galvanized; similar to EN 60715; silver-colored	www.wago.com/210-506
	Item no.: 210-508 Steel carrier rail; 35 x 15 mm; 1.5 mm thick; 2 m long; slotted; galvanized; similar to EN 60715; silver-colored	www.wago.com/210-508

Downloads

Documentation

Manual			
Controller Modbus TCP; G4; 2ETH Generation 4; 2 x ETHERNET	V 1.0.2 Dec 9, 2019	pdf 7.4 MB	Download
Bid Text			
750-891 X81 - Datei	Feb 19, 2019	xml 8.2 kB	Download
750-891 doc - Datei	Nov 19, 2018	doc 33.3 kB	Download
System Description			
Overview on WAGO-I/O-SYSTEM 750 approvals		pdf 780.2 kB	Download
750 Controller, General Product Information		pdf 621.9 kB	Download
Use in Hazardous Environments Term definition, marking and installation regulations	V 1.0.0	pdf 1.0 MB	Download
Additional Information			
Disposal; Electrical and electronic equipment, Packaging	V 1.0.0	pdf 265.8 kB	Download

Subject to changes. Please also observe the further product documentation!



Runtime Software

Firmware

Firmware: 750-891 Controller Modbus TCP; 4th generation; 2 x ETHERNET; light gray	07 Sep 16, 2020	zip 4.2 MB	Download
---	--------------------	---------------	----------

CAD/CAE-Data

CAD data

2D/3D Models 750-891	URL	Download
----------------------	-----	----------

CAE data

ZUKEN Portal 750-891	URL	Download
----------------------	-----	----------

Installation Notes

Product family

Controller 750
[Show all products from the family](#)

Subject to changes. Please also observe the further product documentation!