

Data sheet | Item number: 750-975

ETHERNET RJ-45 connector, IP20; ETHERNET 10/100 Mbit/s; for field assembly; light gray

www.wago.com/750-975

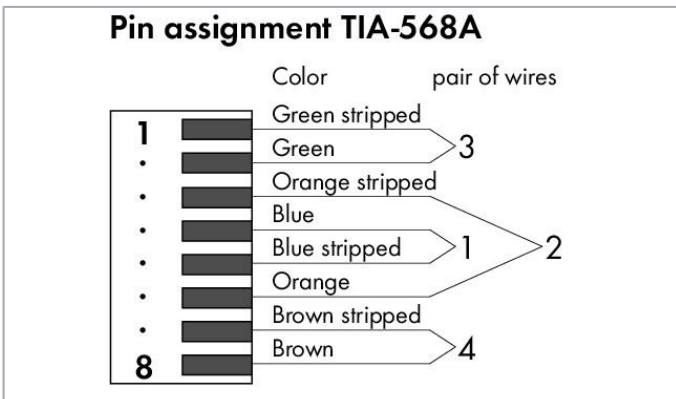
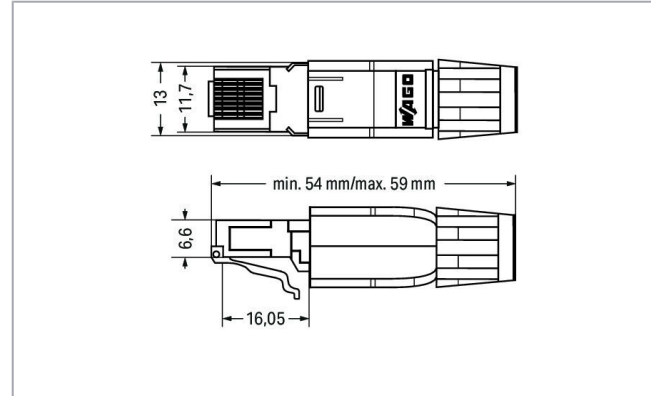

Item description

Versatile RJ-45 connector for industrial, office and building wiring applications.

This compact RJ-45 ETHERNET Connector uses IDC technology for easy field assembly.

Conductor termination is performed without any tools. The connector is compliant with all required standards. Large conductor cross-sections can also be connected. The connector complies with Category 5e.

Subject to changes. Please also observe the further product documentation!

WAGO Kontakttechnik GmbH & Co. KG
Hansastr. 27
32423 Minden
Phone: +49571 887-0 | Fax: +49571 887-169
Email: info.de@wago.com | Web: www.wago.com

Do you have any questions about our products?
We are always happy to take your call at 01788 568 008.



Data

Technical Data

Connection type	RJ-45 plug
Pole No.	8
Cable connection direction to mating direction	0°
Communication/Fieldbus	Ethernet
Code	TIA-568A
Baud rate	-
Insulation resistance	(100 V) > 1 GΩ

Connection data

Connection type (1)	IDC contact
Solid conductor	0.13 ... 0.24 mm ² / 26/1 ... 23/1 AWG
Stranded conductor 2	0.14 ... 0.36 mm ² / 26/7 ... 22/7 AWG

Physical data

Width	14 mm
Height	14 mm
Depth	59 mm

Mechanical data

Shield	Brass (CuZn); hot-dip tinned 3 μm; Shield contact: large surface >180°
Connection requirement (permissible cable type)	Cat. 5e
Connectable sheathed cable diameter	4.5 ... 8 mm
Housing material	Plastic
Contact material	Bronze (CuSn6)
Contact plating	> 1.2 μm gold over 1.2 μm nickel
Mating cycles (max.)	1,000
Weight	12 g
Color	light gray

Environmental Requirements

Surrounding air temperature (operation)	-20 ... 70 °C
Surrounding air temperature (storage)	-40 ... 70 °C

Subject to changes. Please also observe the further product documentation!







Protection type	IP20
Relative humidity (without condensation)	95 %
Vibration resistance	4g per IEC 60068-2-6
Standards/specifications	- Basic standard: IEC 60603-7 RJ-45 Category 5; - CD ISO/IEC 11801: 2002; - EN 50173: 2002; - EIA/TIA 568A: 2002

Commercial data

Product Group	15 (Remote I/O)
Packaging type	BOX
Country of origin	CH
GTIN	4045454482480
Customs tariff number	85366990990

Approvals / Certificates

Ship Approvals

Logo	Approval	Additional Approval Text	Certificate name
	ABS American Bureau of Shipping	-	19- HG1821926
	BV Bureau Veritas S.A.	-	30389/B0 BV
	DNV GL Det Norske Veritas, Germanischer Lloyd	-	TAA0000194
	KR Korean Register of Shipping	-	KR HMB05880- AC001
	LR Lloyds Register	-	02/20026 (E6)
	NK Nippon Kaiji Kyokai	-	TA17255M

Subject to changes. Please also observe the further product documentation!



PRS
Polski Rejestr Statków

-

TE/2236
/880590/19



RINA
RINA Germany GmbH

-

ELE066419XG

UL-Approvals

Logo	Approval	Additional Approval Text	Certificate name
	UL Underwriters Laboratories Inc.	UL 1977	E345416

Downloads

Documentation

Bid Text

750-975 X81 - Datei	Feb 19, 2019	xml 5.5 kB	Download
750-975 doc - Datei	Oct 6, 2017	doc 27.6 kB	Download

Additional Information

Disposal; Electrical and electronic equipment, Packaging	V 1.0.0	pdf 265.8 kB	Download
--	---------	-----------------	----------

System Description

Overview on WAGO-I/O-SYSTEM 750 approvals		pdf 780.2 kB	Download
---	--	-----------------	----------

CAD/CAE-Data

CAE data

EPLAN Data Portal 750-975		URL	Download
---------------------------	--	-----	----------

Subject to changes. Please also observe the further product documentation!



Installation Notes

Subject to changes. Please also observe the further product documentation!

WAGO Kontakttechnik GmbH & Co. KG
Hansastr. 27
32423 Minden
Phone: +49571 887-0 | Fax: +49571 887-169
Email: info.de@wago.com | Web: www.wago.com

Do you have any questions about our products?
We are always happy to take your call at 01788 568 008.