

**Data sheet | Item number: 2000-2231**

Double-deck terminal block; Through/through terminal block; L/L; with marker carrier; for DIN-rail 35 x 15 and 35 x 7.5; Push-in CAGE CLAMP®; 1,00 mm²; gray

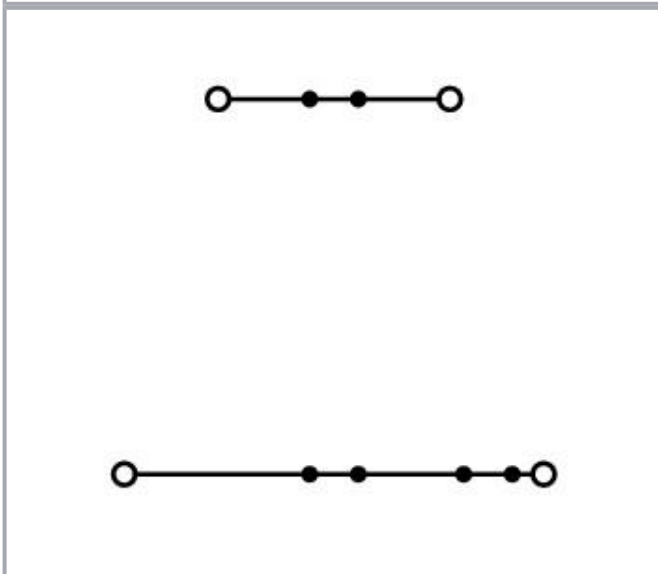

[www.wago.com/2000-2231](http://www.wago.com/2000-2231)

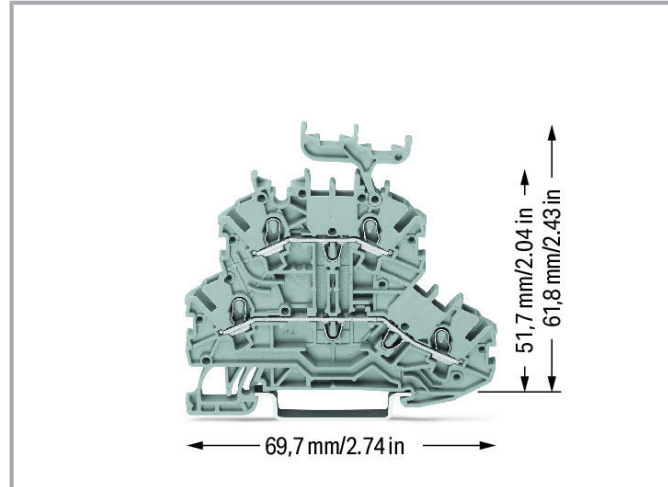
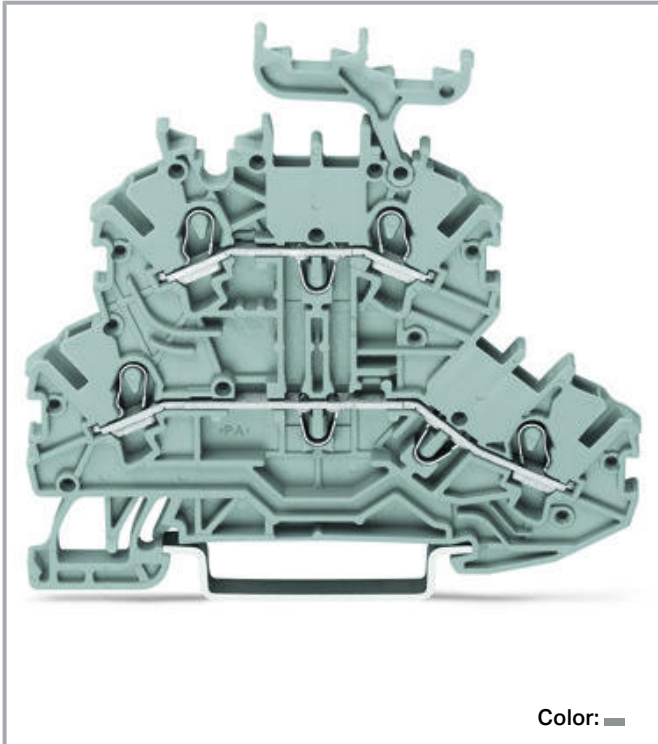

Subject to changes. Please also observe the further product documentation!

WAGO Kontakttechnik GmbH & Co. KG  
Hansastr. 27  
32423 Minden  
Phone: +49571 887-0 | Fax: +49571 887-169  
Email: [info.de@wago.com](mailto:info.de@wago.com) | Web: [www.wago.com](http://www.wago.com)

Do you have any questions about our products?  
We are always happy to take your call at 01788 568 008.



## Data

### Electrical data

#### Ratings per IEC/EN

Ratings per	IEC/EN 60947-7-1
Nominal voltage (III/3)	500 V
Rated surge voltage (III/3)	6 kV
Rated current	13.5 A
Rated current 2	16 A
Legend (ratings)	(III / 3) ≙ Overvoltage category III / Pollution degree 3

#### Ratings per UL

Approvals per	UL 1059
Rated voltage UL (Use Group B)	300 V
Rated current UL (Use Group B)	15 A
Rated voltage UL (Use Group C)	300 V
Rated current UL (Use Group C)	15 A

#### Ratings per CSA

Approvals per	C22.2 No 158
Rated voltage CSA (Use Group B)	600 V
Rated current CSA (Use Group B)	10 A
Rated voltage CSA (Use Group C)	600 V
Rated current CSA (Use Group C)	10 A

#### Ex information

Ratings per	ATEX: PTB 11 ATEX 1041 U / IECEx: PTB 11.0093U (Ex eb IIC Gb)
Rated voltage EN (Ex e II)	350 V
Rated current (Ex e II)	13 A
Rated current (Ex e II) with jumper	12 A

#### Connection data

Total number of connection points	4
Total number of potentials	2
Number of levels	2
Number of jumper slots	4

Subject to changes. Please also observe the further product documentation!

WAGO Kontakttechnik GmbH & Co. KG  
 Hansastr. 27  
 32423 Minden  
 Phone: +49571 887-0 | Fax: +49571 887-169  
 Email: [info.de@wago.com](mailto:info.de@wago.com) | Web: [www.wago.com](http://www.wago.com)

Do you have any questions about our products?  
 We are always happy to take your call at 01788 568 008.



## Connection 1

Connection technology	Push-in CAGE CLAMP®
Number of connection points	2
Actuation type	Push-in Operating tool
Connectable conductor materials	Copper
Nominal cross-section	1 mm <sup>2</sup>
Solid conductor	0.14 ... 1.5 mm <sup>2</sup> / 24 ... 16 AWG
Solid conductor; push-in termination	0.5 ... 1.5 mm <sup>2</sup> / 20 ... 16 AWG
Fine-stranded conductor	0.14 ... 1.5 mm <sup>2</sup> / 24 ... 16 AWG
Fine-stranded conductor; with insulated ferrule	0.14 ... 0.75 mm <sup>2</sup> / 24 ... 18 AWG
Fine-stranded conductor; with ferrule; push-in termination	0.5 ... 0.75 mm <sup>2</sup> / 20 ... 18 AWG
Note (conductor cross-section)	Depending on the conductor characteristic, a conductor with a smaller cross-section can also be inserted via push-in termination.
Conductor diameter	24 ... 16 AWG
Strip length	9 ... 11 mm / 0.35 ... 0.43 inch
Wiring direction	Front-entry wiring

## Connection 2

Number of connection points 2	2
-------------------------------	---

## Physical data

Width	3.5 mm / 0.138 inch
Height	69.7 mm / 2.744 inch
Depth from upper edge of DIN-rail	61.8 mm / 2.433 inch

## Mechanical data

Potentialkennzeichnung	L/L
Design	horizontal type
Mounting type	DIN-35 rail
Marking level	Center/side marking

## Material data

Color	gray
Insulation material	Polyamide (PA66)
Flammability class per UL94	V0

Subject to changes. Please also observe the further product documentation!



Fire load	0.162 MJ
Weight	7.7 g

### Commercial data

Product Group	22 (TOPJOB S)
PU (SPU)	50 Stück
Packaging type	box
Country of origin	DE
GTIN	4045454998134
Customs tariff number	85369010000

### Approvals / Certificates

#### Ex-Approvals

Logo	Approval	Additional Approval Text	Certificate name
	AEx Underwriters Laboratories Inc.	UL 60079	E185892
	ATEX Physikalisch Technische Bundesanstalt	EN 60079	PTB 11 ATEX 1041 U (II 2 G Ex eb IIC Gb bzw. I M 2 Ex eb I Mb)
	CCCEX CQST/CNEx	CNCA-C23-01	2020312313000182
	EAC Brjansker Zertifizierungsstelle	TP TC 012/2011	RU C-DE.AM02.B. 00127/19
	IECEX Physikalisch Technische Bundesanstalt	IEC 60079	IECEX PTB 11.0093 U (Ex e IIC Gb or Ex e I Mb)

#### Country specific Approvals

Logo	Approval	Additional Approval Text	Certificate name
	CCA DEKRA Certification B.V.	EN 60947	71- 102841

Subject to changes. Please also observe the further product documentation!



	<b>CCA</b> DEKRA Certification B.V.	EN 60947	NTR NL 7671
--	--	----------	----------------

#### UL-Approvals

Logo	Approval	Additional Approval Text	Certificate name
	<b>UL</b> Underwriters Laboratories Inc.	UL 1059	20190930- E45172

#### Required accessories

##### End plate



End plate	Item no.: 2000-2292	www.wago.com/2000-2292
	End plate; 0.7 mm thick; orange	
	<b>Item no.: 2000-2291</b> End plate; 0.7 mm thick; gray	www.wago.com/2000-2291

#### Optional accessories

##### Protective warning marker

Cover	Item no.: 2000-115	www.wago.com/2000-115
	Protective warning marker; with high-voltage symbol, black; for 5 terminal blocks; yellow	













##### Testing and measuring

Testing accessories	Item no.: 2009-174	www.wago.com/2009-174
	Test plug adapter; for 4 mm Ø test plugs; for testing TOPJOB®S rail-mounted terminal blocks; gray	
	<b>Item no.: 2009-182</b> Testing tap; for max. 2.5 mm <sup>2</sup> ; tool-free connection for individual test wires 0.08 - 2.5 mm; gray	www.wago.com/2009-182

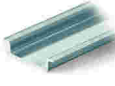
##### Ferrule

Ferrule	Item no.: 216-241	www.wago.com/216-241
	Ferrule; Sleeve for 0.5 mm <sup>2</sup> / 20 AWG; insulated; electro-tin plated; electrolytic copper; gastight crimped; acc. to DIN 46228, Part 4/09.90; white	

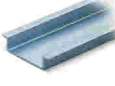
Subject to changes. Please also observe the further product documentation!

	<b>Item no.: 216-242</b> Ferrule; Sleeve for 0.75 mm <sup>2</sup> / 18 AWG; insulated; electro-tin plated; electrolytic copper; gastight crimped; acc. to DIN 46228, Part 4/09.90; gray	<a href="http://www.wago.com/216-242">www.wago.com/216-242</a>
	<b>Item no.: 216-243</b> Ferrule; Sleeve for 1 mm <sup>2</sup> / AWG 18; insulated; electro-tin plated; electrolytic copper; gastight crimped; acc. to DIN 46228, Part 4/09.90; red	<a href="http://www.wago.com/216-243">www.wago.com/216-243</a>
<b>Tool</b>		
Operating tool		
	<b>Item no.: 210-648</b> Operating tool; Blade: 2.5 x 0.4 mm; with a partially insulated shaft; angled; short	<a href="http://www.wago.com/210-648">www.wago.com/210-648</a>
	<b>Item no.: 210-647</b> Operating tool; Blade: 2.5 x 0.4 mm; with a partially insulated shaft; multicoloured	<a href="http://www.wago.com/210-647">www.wago.com/210-647</a>
	<b>Item no.: 210-719</b> Operating tool; Blade: 2.5 x 0.4 mm; with a partially insulated shaft	<a href="http://www.wago.com/210-719">www.wago.com/210-719</a>
<b>Carrier rail</b>		
Mounting accessories		
	<b>Item no.: 210-197</b> Steel carrier rail; 35 x 15 mm; 1.5 mm thick; 2 m long; slotted; similar to EN 60715; silver-colored	<a href="http://www.wago.com/210-197">www.wago.com/210-197</a>
	<b>Item no.: 210-198</b> Copper carrier rail; 35 x 15 mm; 2.3 mm thick; 2 m long; unslotted; according to EN 60715; copper-colored	<a href="http://www.wago.com/210-198">www.wago.com/210-198</a>
	<b>Item no.: 210-113</b> Steel carrier rail; 35 x 7.5 mm; 1 mm thick; 2 m long; unslotted; according to EN 60715; silver-colored	<a href="http://www.wago.com/210-113">www.wago.com/210-113</a>
	<b>Item no.: 210-118</b> Steel carrier rail; 35 x 15 mm; 2.3 mm thick; 2 m long; unslotted; according to EN 60715; silver-colored	<a href="http://www.wago.com/210-118">www.wago.com/210-118</a>
	<b>Item no.: 210-112</b> Steel carrier rail; 35 x 7.5 mm; 1 mm thick; 2 m long; slotted; according to EN 60715; "Hole width 25 mm; silver-colored	<a href="http://www.wago.com/210-112">www.wago.com/210-112</a>
	<b>Item no.: 210-114</b> Steel carrier rail; 35 x 15 mm; 1.5 mm thick; 2 m long; unslotted; similar to EN 60715; silver-colored	<a href="http://www.wago.com/210-114">www.wago.com/210-114</a>
	<b>Item no.: 210-115</b> Steel carrier rail; 35 x 7.5 mm; 1 mm thick; 2 m long; slotted; according to EN 60715; "Hole width 18 mm; silver-colored	<a href="http://www.wago.com/210-115">www.wago.com/210-115</a>
	<b>Item no.: 210-196</b> Aluminum carrier rail; 35 x 8.2 mm; 1.6 mm thick; 2 m long; unslotted; similar to EN 60715; silver-colored	<a href="http://www.wago.com/210-196">www.wago.com/210-196</a>
<b>Push-in type wire jumper</b>		
Jumper		
	<b>Item no.: 2009-404</b> Push-in type wire jumper; 0.75 mm <sup>2</sup> ; insulated; 110 mm long; gray	<a href="http://www.wago.com/2009-404">www.wago.com/2009-404</a>

Subject to changes. Please also observe the further product documentation!



**Item no.: 2009-402**  
Push-in type wire jumper; 0.75 mm<sup>2</sup>; insulated; 60 mm long; gray

[www.wago.com/2009-402](http://www.wago.com/2009-402)



**Item no.: 2009-406**  
Push-in type wire jumper; 0.75 mm<sup>2</sup>; insulated; 250 mm long; gray

[www.wago.com/2009-406](http://www.wago.com/2009-406)

## Jumpers

### Jumper

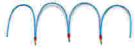

**Item no.: 210-123**  
Wire commoning chain; insulated; blue

[www.wago.com/210-123](http://www.wago.com/210-123)



**Item no.: 2000-408**  
Jumper; 8-way; insulated; light gray

[www.wago.com/2000-408](http://www.wago.com/2000-408)



**Item no.: 2000-407**  
Jumper; 7-way; insulated; light gray

[www.wago.com/2000-407](http://www.wago.com/2000-407)



**Item no.: 2000-409**  
Jumper; 9-way; insulated; light gray

[www.wago.com/2000-409](http://www.wago.com/2000-409)



**Item no.: 2000-408/000-006**  
Jumper; 8-way; insulated; blue

[www.wago.com/2000-408/000-006](http://www.wago.com/2000-408/000-006)



**Item no.: 2000-408/000-005**  
Jumper; 8-way; insulated; red

[www.wago.com/2000-408/000-005](http://www.wago.com/2000-408/000-005)



**Item no.: 2000-409/000-005**  
Jumper; 9-way; insulated; red

[www.wago.com/2000-409/000-005](http://www.wago.com/2000-409/000-005)



**Item no.: 2000-407/000-006**  
Jumper; 7-way; insulated; blue

[www.wago.com/2000-407/000-006](http://www.wago.com/2000-407/000-006)



**Item no.: 2000-410**  
Jumper; 10-way; insulated; light gray

[www.wago.com/2000-410](http://www.wago.com/2000-410)



**Item no.: 2000-410/000-006**  
Jumper; 10-way; insulated; blue













[www.wago.com/2000-410/000-006](http://www.wago.com/2000-410/000-006)



**Item no.: 2000-433/000-005**  
Jumper; from 1 to 3; insulated; red















[www.wago.com/2000-433/000-005](http://www.wago.com/2000-433/000-005)

Subject to changes. Please also observe the further product documentation!

	<b>Item no.: 2000-407/000-005</b> Jumper; 7-way; insulated; red	<a href="http://www.wago.com/2000-407/000-005">www.wago.com/2000-407/000-005</a>
	<b>Item no.: 2000-433/000-006</b> Jumper; from 1 to 3; insulated; blue	<a href="http://www.wago.com/2000-433/000-006">www.wago.com/2000-433/000-006</a>
	<b>Item no.: 2000-410/000-005</b> Jumper; 10-way; insulated; red	<a href="http://www.wago.com/2000-410/000-005">www.wago.com/2000-410/000-005</a>
	<b>Item no.: 2000-435</b> Jumper; from 1 to 5; insulated; light gray	<a href="http://www.wago.com/2000-435">www.wago.com/2000-435</a>
	<b>Item no.: 2000-409/000-006</b> Jumper; 9-way; insulated; blue	<a href="http://www.wago.com/2000-409/000-006">www.wago.com/2000-409/000-006</a>
	<b>Item no.: 2000-436</b> Jumper; from 1 to 6; insulated; light gray	<a href="http://www.wago.com/2000-436">www.wago.com/2000-436</a>
	<b>Item no.: 2000-433</b> Jumper; from 1 to 3; insulated; light gray	<a href="http://www.wago.com/2000-433">www.wago.com/2000-433</a>
	<b>Item no.: 2000-434</b> Jumper; from 1 to 4; insulated; light gray	<a href="http://www.wago.com/2000-434">www.wago.com/2000-434</a>
	<b>Item no.: 2000-402</b> Jumper; 2-way; insulated; light gray	<a href="http://www.wago.com/2000-402">www.wago.com/2000-402</a>
	<b>Item no.: 2000-402/000-006</b> Jumper; 2-way; insulated; blue	<a href="http://www.wago.com/2000-402/000-006">www.wago.com/2000-402/000-006</a>
	<b>Item no.: 2000-403</b> Jumper; 3-way; insulated; light gray	<a href="http://www.wago.com/2000-403">www.wago.com/2000-403</a>
	<b>Item no.: 2000-402/000-005</b> Jumper; 2-way; insulated; red	<a href="http://www.wago.com/2000-402/000-005">www.wago.com/2000-402/000-005</a>
	<b>Item no.: 2000-402/000-018</b> Jumper; 2-way; insulated; yellow-green	<a href="http://www.wago.com/2000-402/000-018">www.wago.com/2000-402/000-018</a>
	<b>Item no.: 2000-404</b> Jumper; 4-way; insulated; light gray	<a href="http://www.wago.com/2000-404">www.wago.com/2000-404</a>
	<b>Item no.: 2000-403/000-005</b> Jumper; 3-way; insulated; red	<a href="http://www.wago.com/2000-403/000-005">www.wago.com/2000-403/000-005</a>

Subject to changes. Please also observe the further product documentation!



	<b>Item no.: 2000-404/000-006</b> Jumper; 4-way; insulated; blue	<a href="http://www.wago.com/2000-404/000-006">www.wago.com/2000-404/000-006</a>
	<b>Item no.: 2000-403/000-006</b> Jumper; 3-way; insulated; blue	<a href="http://www.wago.com/2000-403/000-006">www.wago.com/2000-403/000-006</a>
	<b>Item no.: 2000-404/000-005</b> Jumper; 4-way; insulated; red	<a href="http://www.wago.com/2000-404/000-005">www.wago.com/2000-404/000-005</a>
	<b>Item no.: 2000-405</b> Jumper; 5-way; insulated; light gray	<a href="http://www.wago.com/2000-405">www.wago.com/2000-405</a>
	<b>Item no.: 2000-405/011-000</b> Star point jumper; 3-way; insulated; light gray	<a href="http://www.wago.com/2000-405/011-000">www.wago.com/2000-405/011-000</a>
	<b>Item no.: 2000-405/000-006</b> Jumper; 5-way; insulated; blue	<a href="http://www.wago.com/2000-405/000-006">www.wago.com/2000-405/000-006</a>
	<b>Item no.: 2000-406/000-006</b> Jumper; 6-way; insulated; blue	<a href="http://www.wago.com/2000-406/000-006">www.wago.com/2000-406/000-006</a>
	<b>Item no.: 2000-405/000-005</b> Jumper; 5-way; insulated; red	<a href="http://www.wago.com/2000-405/000-005">www.wago.com/2000-405/000-005</a>
	<b>Item no.: 2000-406</b> Jumper; 6-way; insulated; light gray	<a href="http://www.wago.com/2000-406">www.wago.com/2000-406</a>
	<b>Item no.: 2000-406/000-005</b> Jumper; 6-way; insulated; red	<a href="http://www.wago.com/2000-406/000-005">www.wago.com/2000-406/000-005</a>
	<b>Item no.: 2000-406/020-000</b> Delta jumper; insulated; light gray	<a href="http://www.wago.com/2000-406/020-000">www.wago.com/2000-406/020-000</a>
	<b>Item no.: 2000-437</b> Jumper; from 1 to 7; insulated; light gray	<a href="http://www.wago.com/2000-437">www.wago.com/2000-437</a>
	<b>Item no.: 2000-438</b> Jumper; from 1 to 8; insulated; light gray	<a href="http://www.wago.com/2000-438">www.wago.com/2000-438</a>
	<b>Item no.: 2000-492</b> Vertical jumper; insulated; light gray	<a href="http://www.wago.com/2000-492">www.wago.com/2000-492</a>
	<b>Item no.: 2000-439</b>	

Subject to changes. Please also observe the further product documentation!

Jumper; from 1 to 9; insulated; light gray

[www.wago.com/2000-439](http://www.wago.com/2000-439)



**Item no.: 2000-440**

Jumper; from 1 to 10; insulated; light gray

[www.wago.com/2000-440](http://www.wago.com/2000-440)



**Item no.: 210-103**

Wire commoning chain; insulated; black

[www.wago.com/210-103](http://www.wago.com/210-103)

**Marking accessories**

Marking strip



**Item no.: 2009-110**

Marking strips; for Smart Printer; on reel; not stretchable; plain; snap-on type; white

[www.wago.com/2009-110](http://www.wago.com/2009-110)

Marker



**Item no.: 2009-113**

WMB-Inline; for Smart Printer; 2300 pieces on roll; plain; snap-on type; white

[www.wago.com/2009-113](http://www.wago.com/2009-113)



**Item no.: 2009-113/000-002**

WMB-Inline; for Smart Printer; 2300 pieces on roll; plain; snap-on type; yellow

[www.wago.com/2009-113/000-002](http://www.wago.com/2009-113/000-002)



**Item no.: 2009-113/000-012**

WMB-Inline; for Smart Printer; 2300 pieces on roll; plain; snap-on type; orange

[www.wago.com/2009-113/000-012](http://www.wago.com/2009-113/000-012)



**Item no.: 2009-113/000-007**

WMB-Inline; for Smart Printer; 2300 pieces on roll; plain; snap-on type; gray

[www.wago.com/2009-113/000-007](http://www.wago.com/2009-113/000-007)



**Item no.: 2009-113/000-005**

WMB-Inline; for Smart Printer; 2300 pieces on roll; plain; snap-on type; red

[www.wago.com/2009-113/000-005](http://www.wago.com/2009-113/000-005)



**Item no.: 2009-113/000-017**

WMB-Inline; for Smart Printer; 2300 pieces on roll; plain; snap-on type; light green

[www.wago.com/2009-113/000-017](http://www.wago.com/2009-113/000-017)



**Item no.: 2009-113/000-006**

WMB-Inline; for Smart Printer; 2300 pieces on roll; plain; snap-on type; blue

[www.wago.com/2009-113/000-006](http://www.wago.com/2009-113/000-006)



**Item no.: 2009-113/000-024**

WMB-Inline; for Smart Printer; 2300 pieces on roll; plain; snap-on type; violet

[www.wago.com/2009-113/000-024](http://www.wago.com/2009-113/000-024)



**Item no.: 2009-113/000-023**

WMB-Inline; for Smart Printer; 2300 pieces on roll; plain; snap-on type; green

[www.wago.com/2009-113/000-023](http://www.wago.com/2009-113/000-023)

**Item no.: 793-3501**

Subject to changes. Please also observe the further product documentation!



WMB marking card; as card; plain; snap-on type; white

## Downloads

### Documentation

#### Bid Text

2000-2231 docx - Datei	Aug 7, 2018	docx 14.8 kB	Download
---------------------------	-------------	-----------------	----------

2000-2231 X81 - Datei	Feb 19, 2019	xml 3.9 kB	Download
--------------------------	--------------	---------------	----------

#### Additional Information

Technical explanations	Apr 3, 2019	pdf 2.2 MB	Download
------------------------	-------------	---------------	----------

## CAD/CAE-Data

### CAD data

2D/3D Models 2000-2231	URL	Download
------------------------	-----	----------

### CAE data

EPLAN Data Portal 2000-2231	URL	Download
-----------------------------	-----	----------

ZUKEN Portal 2000-2231	URL	Download
------------------------	-----	----------

WSCAD Universe 2000-2231	URL	Download
--------------------------	-----	----------

## Environmental Product Compliance

### Compliance Search

Environmental Product Compliance 2000-2231	URL	Download
--	-----	----------

Double-deck terminal block; Through/through terminal block; L/L; with marker carrier; for DIN-rail 35 x 15 and 35 x 7.5; Push-in CAGE CLAMP®; 1,00 mm²; gray

## Installation Notes

Subject to changes. Please also observe the further product documentation!

WAGO Kontakttechnik GmbH & Co. KG  
 Hansastr. 27  
 32423 Minden  
 Phone: +49571 887-0 | Fax: +49571 887-169  
 Email: [info.de@wago.com](mailto:info.de@wago.com) | Web: [www.wago.com](http://www.wago.com)

Do you have any questions about our products?  
 We are always happy to take your call at 01788 568 008.

### Conductor termination

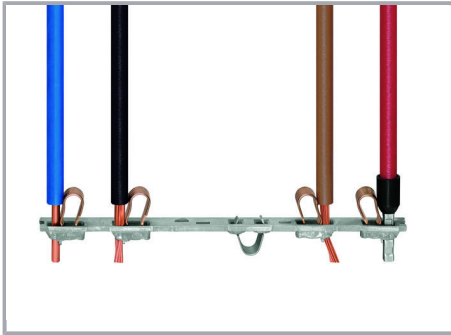

All conductor types at a glance

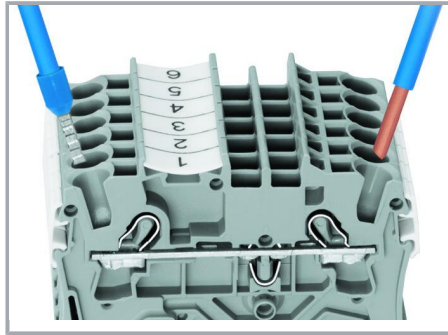

Push-in termination of solid and ferruled conductors

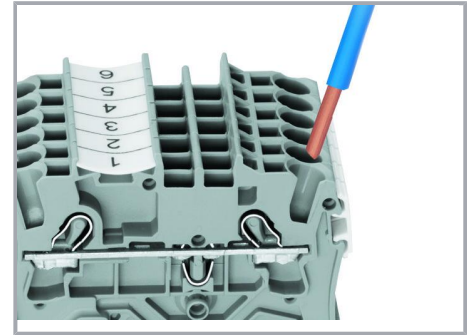

Inserting a conductor via push-in termination:

Solid conductors with cross-sections from either one size above, or up to two sizes below, the rated cross-section can be simply pushed in – no tools needed.



Inserting a conductor via operating tool:

Connecting fine-stranded conductors without ferrules, or small cross-sectional conductors that cannot be pushed in, is performed similarly to the original CAGE CLAMP® – just use an operating tool.

#### Advantage:

To open the clamp, the operating tool is inserted vertically. The conductor entry is less than 15 degrees for easier wiring.



Conductor termination – insulation stop

### Commoning

Subject to changes. Please also observe the further product documentation!



Commoning two levels via double-deck vertical jumper (2000-492).

### Marking

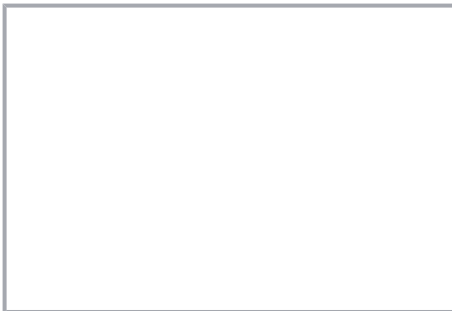

Snapping WMB Inline markers into marker slots.

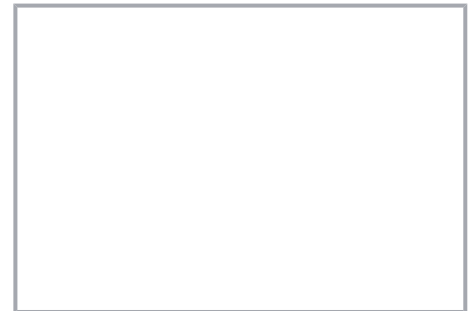
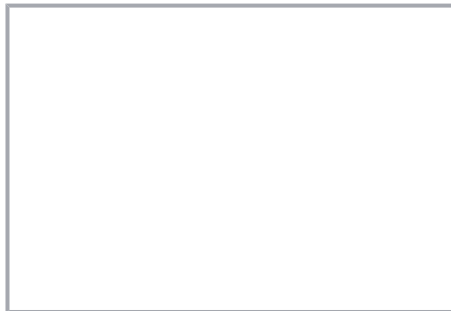

### Double-Deck Terminal Blocks

A double-deck marker carrier (2000-121) can be retrofitted to double-deck terminal blocks without a marker carrier.

### Product family

#### TOPJOB® S

TOPJOB® S: In various industrial applications and modern building installations, WAGO's wide and versatile range of rail-mount terminal blocks provides more than just reliable electrical connections.

[Show all products from the family](#)

Subject to changes. Please also observe the further product documentation!