

**Data sheet | Item number: 2002-3204**

Triple-deck terminal block; Through/through/through terminal block; N/N/N;  
without marker carrier; for Ex e II and Ex i applications; for DIN-rail 35 x 15  
and 35 x 7.5; 2.5 mm<sup>2</sup>; Push-in CAGE CLAMP®; 2,50 mm<sup>2</sup>; blue

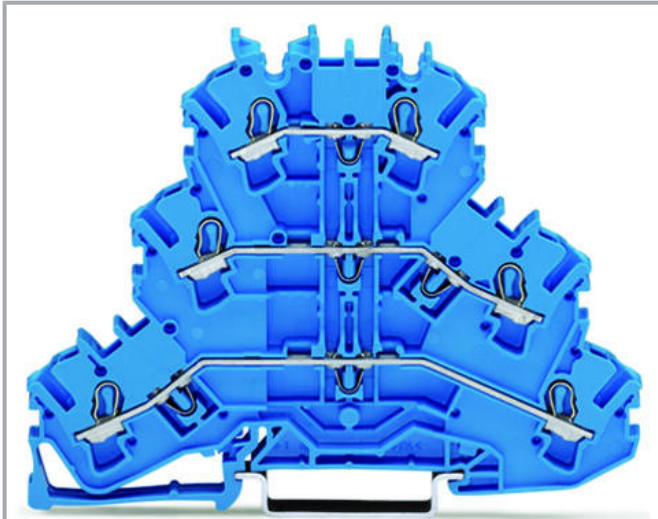

[www.wago.com/2002-3204](http://www.wago.com/2002-3204)



Color: 

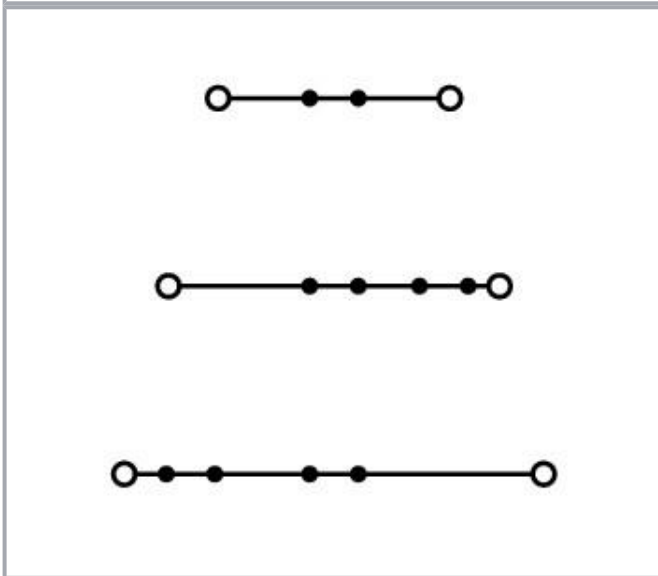
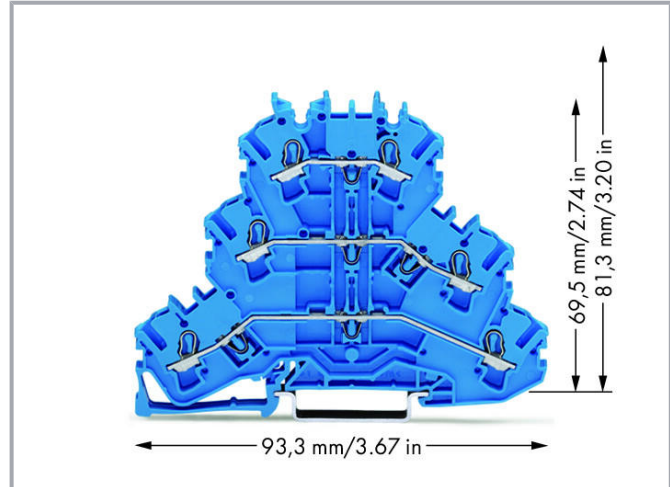

**Data**

**Electrical data**

Subject to changes. Please also observe the further product documentation!

WAGO Kontakttechnik GmbH & Co. KG  
Hansastr. 27  
32423 Minden  
Phone: +49571 887-0 | Fax: +49571 887-169  
Email: [info.de@wago.com](mailto:info.de@wago.com) | Web: [www.wago.com](http://www.wago.com)

Do you have any questions about our products?  
We are always happy to take your call at 01788 568 008.



### Ratings per IEC/EN

Ratings per	IEC/EN 60947-7-1
Nominal voltage (III/3)	500 V
Rated surge voltage (III/3)	6 kV
Rated current	24 A
Rated current 2	28 A
Legend (ratings)	(III / 3) ≙ Overvoltage category III / Pollution degree 3

### Ratings per UL

Approvals per	UL 1059
Rated voltage UL (Use Group B)	300 V
Rated current UL (Use Group B)	20 A
Rated voltage UL (Use Group C)	300 V
Rated current UL (Use Group C)	20 A
Rated voltage UL (Use Group D)	600 V
Rated current UL (Use Group D)	5 A

### Ratings per CSA

Approvals per	C22.2 No 158
Rated voltage CSA (Use Group B)	600 V
Rated current CSA (Use Group B)	20 A
Rated voltage CSA (Use Group C)	600 V
Rated current CSA (Use Group C)	20 A

### Ex information

Ratings per	ATEX: PTB 03 ATEX 1162 U / IECEx: PTB 03.0004U (Ex eb IIC Gb)
Rated voltage EN (Ex e II)	440 V
Rated current (Ex e II)	19 A
Rated current (Ex e II) with jumper	17 A

### Connection data

Total number of connection points	6
Total number of potentials	3
Number of levels	3
Number of jumper slots	6

Subject to changes. Please also observe the further product documentation!

WAGO Kontakttechnik GmbH & Co. KG  
 Hansastr. 27  
 32423 Minden  
 Phone: +49571 887-0 | Fax: +49571 887-169  
 Email: [info.de@wago.com](mailto:info.de@wago.com) | Web: [www.wago.com](http://www.wago.com)

Do you have any questions about our products?  
 We are always happy to take your call at 01788 568 008.



## Connection 1

Connection technology	Push-in CAGE CLAMP®
Number of connection points	3
Actuation type	Push-in Operating tool
Connectable conductor materials	Copper
Nominal cross-section	2.5 mm <sup>2</sup>
Solid conductor	0.25 ... 4 mm <sup>2</sup> / 22 ... 12 AWG
Solid conductor; push-in termination	0.75 ... 4 mm <sup>2</sup> / 18 ... 12 AWG
Fine-stranded conductor	0.25 ... 4 mm <sup>2</sup> / 22 ... 12 AWG
Fine-stranded conductor; with insulated ferrule	0.25 ... 2.5 mm <sup>2</sup> / 22 ... 14 AWG
Fine-stranded conductor; with ferrule; push-in termination	1 ... 2.5 mm <sup>2</sup> / 18 ... 14 AWG
Note (conductor cross-section)	Depending on the conductor characteristic, a conductor with a smaller cross-section can also be inserted via push-in termination.
Conductor diameter	22 ... 12 AWG
Strip length	10 ... 12 mm / 0.39 ... 0.47 inch
Wiring direction	Front-entry wiring

## Connection 2

Number of connection points 2	3
-------------------------------	---

## Physical data

Width	5.2 mm / 0.205 inch
Height	93.3 mm / 3.673 inch
Depth from upper edge of DIN-rail	69.5 mm / 2.736 inch

## Mechanical data

Potentialkennzeichnung	N/N/N
Design	horizontal type
Mounting type	DIN-35 rail
Marking level	Center/side marking

## Material data

Color	blue
Insulation material	Polyamide (PA66)
Flammability class per UL94	V0

Subject to changes. Please also observe the further product documentation!





Fire load	0.316 MJ
Weight	16.8 g

### Commercial data

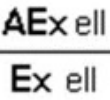

Product Group	22 (TOPJOB S)
PU (SPU)	50 Stück
Packaging type	box
Country of origin	DE
GTIN	4044918963572
Customs tariff number	85369010000

### Approvals / Certificates

#### Ex-Approvals

Logo	Approval	Additional Approval Text	Certificate name
	AEx Underwriters Laboratories Inc.	UL 60079	E185892
	ATEX Physikalisch Technische Bundesanstalt (PTB)	EN 60079	PTB 03 ATEX 1162 U (II 2 G Ex eb IIC Gb bzw. I M 2 Ex eb I Mb)
	CCCEX CQST/CNEx	CNCA-C23-01	2020312313000238
	EAC Brjansker Zertifizierungsstelle	TP TC 012/2011	RU C-DE.AM02.B. 00127/19

#### Country specific Approvals

Logo	Approval	Additional Approval Text	Certificate name
	CCA DEKRA Certification B.V.	EN 60947	71- 107687
	CCA DEKRA Certification B.V.	EN 60947	NTR NL 7730

Subject to changes. Please also observe the further product documentation!





CCA  
DEKRA Certification B.V.

C22.2 No. 158

1536069

### Ship Approvals

Logo	Approval	Additional Approval Text	Certificate name
	<b>ABS</b> American Bureau of Shipping	EN 60947	20- HG1941090- PDA
	<b>BV</b> Bureau Veritas S.A.	EN 60947	38586/A0 BV
	<b>DNV GL</b> Det Norske Veritas, Germanischer Lloyd	-	TAE00001V2

### UL-Approvals

Logo	Approval	Additional Approval Text	Certificate name
	<b>UL</b> Underwriters Laboratories Inc.	UL 1059	E45172

### Required accessories

#### End plate

End plate



**Item no.: 2002-3292**  
End and intermediate plate; 0.8 mm thick; orange

[www.wago.com/2002-3292](http://www.wago.com/2002-3292)



**Item no.: 2002-3291**  
End and intermediate plate; 0.8 mm thick; gray













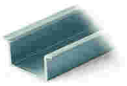

[www.wago.com/2002-3291](http://www.wago.com/2002-3291)

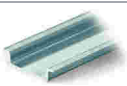
### Optional accessories

#### Carrier rail







Mounting accessories

Subject to changes. Please also observe the further product documentation!

	<b>Item no.: 210-197</b> Steel carrier rail; 35 x 15 mm; 1.5 mm thick; 2 m long; slotted; similar to EN 60715; silver-colored	<a href="http://www.wago.com/210-197">www.wago.com/210-197</a>
	<b>Item no.: 210-198</b> Copper carrier rail; 35 x 15 mm; 2.3 mm thick; 2 m long; unslotted; according to EN 60715; copper-colored	<a href="http://www.wago.com/210-198">www.wago.com/210-198</a>
	<b>Item no.: 210-504</b> Steel carrier rail; 35 x 7.5 mm; 1 mm thick; 2 m long; slotted; galvanized; according to EN 60715; silver-colored	<a href="http://www.wago.com/210-504">www.wago.com/210-504</a>
	<b>Item no.: 210-505</b> Steel carrier rail; 35 x 7.5 mm; 1 mm thick; 2 m long; unslotted; galvanized; according to EN 60715; silver-colored	<a href="http://www.wago.com/210-505">www.wago.com/210-505</a>
	<b>Item no.: 210-506</b> Steel carrier rail; 35 x 15 mm; 1.5 mm thick; 2 m long; unslotted; galvanized; similar to EN 60715; silver-colored	<a href="http://www.wago.com/210-506">www.wago.com/210-506</a>
	<b>Item no.: 210-508</b> Steel carrier rail; 35 x 15 mm; 1.5 mm thick; 2 m long; slotted; galvanized; similar to EN 60715; silver-colored	<a href="http://www.wago.com/210-508">www.wago.com/210-508</a>
	<b>Item no.: 210-113</b> Steel carrier rail; 35 x 7.5 mm; 1 mm thick; 2 m long; unslotted; according to EN 60715; silver-colored	<a href="http://www.wago.com/210-113">www.wago.com/210-113</a>
	<b>Item no.: 210-118</b> Steel carrier rail; 35 x 15 mm; 2.3 mm thick; 2 m long; unslotted; according to EN 60715; silver-colored	<a href="http://www.wago.com/210-118">www.wago.com/210-118</a>
	<b>Item no.: 210-112</b> Steel carrier rail; 35 x 7.5 mm; 1 mm thick; 2 m long; slotted; according to EN 60715; "Hole width 25 mm; silver-colored	<a href="http://www.wago.com/210-112">www.wago.com/210-112</a>
	<b>Item no.: 210-114</b> Steel carrier rail; 35 x 15 mm; 1.5 mm thick; 2 m long; unslotted; similar to EN 60715; silver-colored	<a href="http://www.wago.com/210-114">www.wago.com/210-114</a>
	<b>Item no.: 210-115</b> Steel carrier rail; 35 x 7.5 mm; 1 mm thick; 2 m long; slotted; according to EN 60715; "Hole width 18 mm; silver-colored	<a href="http://www.wago.com/210-115">www.wago.com/210-115</a>
	<b>Item no.: 210-196</b> Aluminum carrier rail; 35 x 8.2 mm; 1.6 mm thick; 2 m long; unslotted; similar to EN 60715; silver-colored	<a href="http://www.wago.com/210-196">www.wago.com/210-196</a>
<b>Ferrule</b>		
Ferrule		
	<b>Item no.: 216-241</b> Ferrule; Sleeve for 0.5 mm <sup>2</sup> / 20 AWG; insulated; electro-tin plated; electrolytic copper; gastight crimped; acc. to DIN 46228, Part 4/09.90; white	<a href="http://www.wago.com/216-241">www.wago.com/216-241</a>
	<b>Item no.: 216-242</b> Ferrule; Sleeve for 0.75 mm <sup>2</sup> / 18 AWG; insulated; electro-tin plated; electrolytic copper; gastight crimped; acc. to DIN 46228, Part 4/09.90; gray	<a href="http://www.wago.com/216-242">www.wago.com/216-242</a>
	<b>Item no.: 216-243</b> Ferrule; Sleeve for 1 mm <sup>2</sup> / AWG 18; insulated; electro-tin plated; electrolytic copper; gastight crimped;	<a href="http://www.wago.com/216-243">www.wago.com/216-243</a>





Subject to changes. Please also observe the further product documentation!

acc. to DIN 46228, Part 4/09.90; red

	<b>Item no.: 216-244</b> Ferrule; Sleeve for 1.5 mm <sup>2</sup> / AWG 16; insulated; electro-tin plated; electrolytic copper; gastight crimped; acc. to DIN 46228, Part 4/09.90; black	<a href="http://www.wago.com/216-244">www.wago.com/216-244</a>
	<b>Item no.: 216-263</b> Ferrule; Sleeve for 1 mm <sup>2</sup> / AWG 18; insulated; electro-tin plated; electrolytic copper; gastight crimped; acc. to DIN 46228, Part 4/09.90; red	<a href="http://www.wago.com/216-263">www.wago.com/216-263</a>
	<b>Item no.: 216-246</b> Ferrule; Sleeve for 2.5 mm <sup>2</sup> / AWG 14; insulated; electro-tin plated; electrolytic copper; gastight crimped; acc. to DIN 46228, Part 4/09.90; blue	<a href="http://www.wago.com/216-246">www.wago.com/216-246</a>
	<b>Item no.: 216-266</b> Ferrule; Sleeve for 2.5 mm <sup>2</sup> / AWG 14; insulated; electro-tin plated; electrolytic copper; gastight crimped; acc. to DIN 46228, Part 4/09.90; blue	<a href="http://www.wago.com/216-266">www.wago.com/216-266</a>
	<b>Item no.: 216-264</b> Ferrule; Sleeve for 1.5 mm <sup>2</sup> / AWG 16; insulated; electro-tin plated; electrolytic copper; gastight crimped; acc. to DIN 46228, Part 4/09.90; black	<a href="http://www.wago.com/216-264">www.wago.com/216-264</a>
	<b>Item no.: 216-262</b> Ferrule; Sleeve for 0.75 mm <sup>2</sup> / 18 AWG; insulated; electro-tin plated; electrolytic copper; gastight crimped; acc. to DIN 46228, Part 4/09.90; gray	<a href="http://www.wago.com/216-262">www.wago.com/216-262</a>





### Testing and measuring

#### Testing accessories

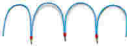

	<b>Item no.: 2009-174</b> Test plug adapter; for 4 mm Ø test plugs; for testing TOPJOB®S rail-mounted terminal blocks; gray	<a href="http://www.wago.com/2009-174">www.wago.com/2009-174</a>
	<b>Item no.: 2009-182</b> Testing tap; for max. 2.5 mm <sup>2</sup> ; tool-free connection for individual test wires 0.08 - 2.5 mm; gray	<a href="http://www.wago.com/2009-182">www.wago.com/2009-182</a>
	<b>Item no.: 2002-611</b> TOPJOB®S L-type test plug module; modular; 1-pole; 2,50 mm <sup>2</sup> ; gray	<a href="http://www.wago.com/2002-611">www.wago.com/2002-611</a>
	<b>Item no.: 2002-649</b> TOPJOB®S L-type spacer module; modular; e.g., for bridging commoned terminal blocks; gray	<a href="http://www.wago.com/2002-649">www.wago.com/2002-649</a>

### Jumpers

#### Jumper















	<b>Item no.: 210-123</b> Wire commoning chain; insulated; blue	<a href="http://www.wago.com/210-123">www.wago.com/210-123</a>
	<b>Item no.: 2002-402</b> Jumper; 2-way; insulated; light gray	<a href="http://www.wago.com/2002-402">www.wago.com/2002-402</a>
	<b>Item no.: 2002-402/000-005</b> Jumper; 2-way; insulated; red	<a href="http://www.wago.com/2002-402/000-005">www.wago.com/2002-402/000-005</a>
	<b>Item no.: 2002-400</b> Continuous jumper; 2-way; insulated; light gray	<a href="http://www.wago.com/2002-400">www.wago.com/2002-400</a>

Subject to changes. Please also observe the further product documentation!









	<b>Item no.: 2002-403</b> Jumper; 3-way; insulated; light gray	<a href="http://www.wago.com/2002-403">www.wago.com/2002-403</a>
	<b>Item no.: 2002-404/000-005</b> Jumper; 4-way; insulated; red	<a href="http://www.wago.com/2002-404/000-005">www.wago.com/2002-404/000-005</a>
	<b>Item no.: 2002-403/000-006</b> Jumper; 3-way; insulated; blue	<a href="http://www.wago.com/2002-403/000-006">www.wago.com/2002-403/000-006</a>
	<b>Item no.: 2002-404/000-006</b> Jumper; 4-way; insulated; blue	<a href="http://www.wago.com/2002-404/000-006">www.wago.com/2002-404/000-006</a>
	<b>Item no.: 2002-403/000-005</b> Jumper; 3-way; insulated; red	<a href="http://www.wago.com/2002-403/000-005">www.wago.com/2002-403/000-005</a>
	<b>Item no.: 2002-405/000-005</b> Jumper; 5-way; insulated; red	<a href="http://www.wago.com/2002-405/000-005">www.wago.com/2002-405/000-005</a>
	<b>Item no.: 2002-402/000-006</b> Jumper; 2-way; insulated; blue	<a href="http://www.wago.com/2002-402/000-006">www.wago.com/2002-402/000-006</a>
	<b>Item no.: 2002-405/000-006</b> Jumper; 5-way; insulated; blue	<a href="http://www.wago.com/2002-405/000-006">www.wago.com/2002-405/000-006</a>
	<b>Item no.: 2002-404</b> Jumper; 4-way; insulated; light gray	<a href="http://www.wago.com/2002-404">www.wago.com/2002-404</a>
	<b>Item no.: 2002-406/000-006</b> Jumper; 6-way; insulated; blue	<a href="http://www.wago.com/2002-406/000-006">www.wago.com/2002-406/000-006</a>
	<b>Item no.: 2002-406/000-005</b> Jumper; 6-way; insulated; red	<a href="http://www.wago.com/2002-406/000-005">www.wago.com/2002-406/000-005</a>
	<b>Item no.: 2002-406/020-000</b> Delta jumper; insulated; light gray	<a href="http://www.wago.com/2002-406/020-000">www.wago.com/2002-406/020-000</a>
	<b>Item no.: 2002-405</b> Jumper; 5-way; insulated; light gray	<a href="http://www.wago.com/2002-405">www.wago.com/2002-405</a>

Subject to changes. Please also observe the further product documentation!

















	<b>Item no.: 2002-407/000-005</b> Jumper; 7-way; insulated; red	<a href="http://www.wago.com/2002-407/000-005">www.wago.com/2002-407/000-005</a>
	<b>Item no.: 2002-408</b> Jumper; 8-way; insulated; light gray	<a href="http://www.wago.com/2002-408">www.wago.com/2002-408</a>
	<b>Item no.: 2002-408/000-006</b> Jumper; 8-way; insulated; blue	<a href="http://www.wago.com/2002-408/000-006">www.wago.com/2002-408/000-006</a>
	<b>Item no.: 2002-405/011-000</b> Star point jumper; 3-way; insulated; light gray	<a href="http://www.wago.com/2002-405/011-000">www.wago.com/2002-405/011-000</a>
	<b>Item no.: 2002-407/000-006</b> Jumper; 7-way; insulated; blue	<a href="http://www.wago.com/2002-407/000-006">www.wago.com/2002-407/000-006</a>
	<b>Item no.: 2002-408/000-005</b> Jumper; 8-way; insulated; red	<a href="http://www.wago.com/2002-408/000-005">www.wago.com/2002-408/000-005</a>
	<b>Item no.: 2002-407</b> Jumper; 7-way; insulated; light gray	<a href="http://www.wago.com/2002-407">www.wago.com/2002-407</a>
	<b>Item no.: 2002-406</b> Jumper; 6-way; insulated; light gray	<a href="http://www.wago.com/2002-406">www.wago.com/2002-406</a>
	<b>Item no.: 2002-410/000-005</b> Jumper; 10-way; insulated; red	<a href="http://www.wago.com/2002-410/000-005">www.wago.com/2002-410/000-005</a>
	<b>Item no.: 2002-410/000-006</b> Jumper; 10-way; insulated; blue	<a href="http://www.wago.com/2002-410/000-006">www.wago.com/2002-410/000-006</a>
	<b>Item no.: 2002-410</b> Jumper; 10-way; insulated; light gray	<a href="http://www.wago.com/2002-410">www.wago.com/2002-410</a>
	<b>Item no.: 2002-409/000-006</b> Jumper; 9-way; insulated; blue	<a href="http://www.wago.com/2002-409/000-006">www.wago.com/2002-409/000-006</a>
	<b>Item no.: 2002-409/000-005</b> Jumper; 9-way; insulated; red	<a href="http://www.wago.com/2002-409/000-005">www.wago.com/2002-409/000-005</a>
		

Subject to changes. Please also observe the further product documentation!

	<b>Item no.: 2002-409</b> Jumper; 9-way; insulated; light gray	<a href="http://www.wago.com/2002-409">www.wago.com/2002-409</a>
	<b>Item no.: 2002-423/000-006</b> Continuous jumper; from 1 to 3; insulated; blue	<a href="http://www.wago.com/2002-423/000-006">www.wago.com/2002-423/000-006</a>
	<b>Item no.: 2002-423</b> Continuous jumper; from 1 to 3; insulated; light gray	<a href="http://www.wago.com/2002-423">www.wago.com/2002-423</a>
	<b>Item no.: 2002-433</b> Jumper; from 1 to 3; insulated; light gray	<a href="http://www.wago.com/2002-433">www.wago.com/2002-433</a>
	<b>Item no.: 2002-434</b> Jumper; from 1 to 4; insulated; light gray	<a href="http://www.wago.com/2002-434">www.wago.com/2002-434</a>
	<b>Item no.: 2002-423/000-005</b> Continuous jumper; from 1 to 3; insulated; red	<a href="http://www.wago.com/2002-423/000-005">www.wago.com/2002-423/000-005</a>
	<b>Item no.: 2002-435</b> Jumper; from 1 to 5; insulated; light gray	<a href="http://www.wago.com/2002-435">www.wago.com/2002-435</a>
	<b>Item no.: 2002-436</b> Jumper; from 1 to 6; insulated; light gray	<a href="http://www.wago.com/2002-436">www.wago.com/2002-436</a>
	<b>Item no.: 2002-437</b> Jumper; from 1 to 7; insulated; light gray	<a href="http://www.wago.com/2002-437">www.wago.com/2002-437</a>
	<b>Item no.: 2002-438</b> Jumper; from 1 to 8; insulated; light gray	<a href="http://www.wago.com/2002-438">www.wago.com/2002-438</a>
	<b>Item no.: 2002-439</b> Jumper; from 1 to 9; insulated; light gray	<a href="http://www.wago.com/2002-439">www.wago.com/2002-439</a>
	<b>Item no.: 2002-440</b> Jumper; from 1 to 10; insulated; light gray	<a href="http://www.wago.com/2002-440">www.wago.com/2002-440</a>
	<b>Item no.: 2002-472</b> Staggered jumper; 2-way; insulated; light gray	<a href="http://www.wago.com/2002-472">www.wago.com/2002-472</a>
	<b>Item no.: 2002-473</b> Staggered jumper; 3-way; insulated; light gray	<a href="http://www.wago.com/2002-473">www.wago.com/2002-473</a>
	<b>Item no.: 2002-475/011-000</b> Staggered jumper; 3-way; insulated; light gray	<a href="http://www.wago.com/2002-475/011-000">www.wago.com/2002-475/011-000</a>
	<b>Item no.: 2002-475</b> Staggered jumper; 5-way; insulated; light gray	<a href="http://www.wago.com/2002-475">www.wago.com/2002-475</a>
	<b>Item no.: 2002-476</b> Staggered jumper; 6-way; insulated; light gray	<a href="http://www.wago.com/2002-476">www.wago.com/2002-476</a>













Subject to changes. Please also observe the further product documentation!

	<b>Item no.: 2002-474</b> Staggered jumper; 4-way; insulated; light gray	<a href="http://www.wago.com/2002-474">www.wago.com/2002-474</a>
	<b>Item no.: 2002-477</b> Staggered jumper; 7-way; insulated; light gray	<a href="http://www.wago.com/2002-477">www.wago.com/2002-477</a>
	<b>Item no.: 2002-473/011-000</b> Staggered jumper; 2-way; from 1 to 3; insulated; light gray	<a href="http://www.wago.com/2002-473/011-000">www.wago.com/2002-473/011-000</a>
	<b>Item no.: 2002-479</b> Staggered jumper; 9-way; insulated; light gray	<a href="http://www.wago.com/2002-479">www.wago.com/2002-479</a>
	<b>Item no.: 2002-478</b> Staggered jumper; 8-way; insulated; light gray	<a href="http://www.wago.com/2002-478">www.wago.com/2002-478</a>
	<b>Item no.: 2002-479/011-000</b> Staggered jumper; insulated; light gray	<a href="http://www.wago.com/2002-479/011-000">www.wago.com/2002-479/011-000</a>
	<b>Item no.: 2002-480</b> Staggered jumper; 10-way; insulated; light gray	<a href="http://www.wago.com/2002-480">www.wago.com/2002-480</a>
	<b>Item no.: 2002-477/011-000</b> Staggered jumper; insulated; light gray	<a href="http://www.wago.com/2002-477/011-000">www.wago.com/2002-477/011-000</a>
	<b>Item no.: 2002-492</b> Vertical jumper; insulated; light gray	<a href="http://www.wago.com/2002-492">www.wago.com/2002-492</a>
	<b>Item no.: 2002-481/011-000</b> Staggered jumper; insulated; light gray	<a href="http://www.wago.com/2002-481/011-000">www.wago.com/2002-481/011-000</a>
	<b>Item no.: 2002-493</b> Vertical jumper; insulated; light gray	<a href="http://www.wago.com/2002-493">www.wago.com/2002-493</a>
	<b>Item no.: 2002-481</b> Staggered jumper; 11-way; insulated; light gray	<a href="http://www.wago.com/2002-481">www.wago.com/2002-481</a>
	<b>Item no.: 2002-492/000-012</b> Vertical jumper; insulated; orange	<a href="http://www.wago.com/2002-492/000-012">www.wago.com/2002-492/000-012</a>
	<b>Item no.: 2002-482</b> Staggered jumper; 12-way; insulated; light gray	<a href="http://www.wago.com/2002-482">www.wago.com/2002-482</a>
	<b>Item no.: 210-103</b> Wire commoning chain; insulated; black	<a href="http://www.wago.com/210-103">www.wago.com/210-103</a>













#### Marking accessories

Marking strip

Subject to changes. Please also observe the further product documentation!

	<b>Item no.: 2009-110</b> Marking strips; for Smart Printer; on reel; not stretchable; plain; snap-on type; white	<a href="http://www.wago.com/2009-110">www.wago.com/2009-110</a>
Marker carrier		
	<b>Item no.: 2009-198</b> Adaptor; gray	<a href="http://www.wago.com/2009-198">www.wago.com/2009-198</a>
	<b>Item no.: 2002-131</b> Adaptor; gray	<a href="http://www.wago.com/2002-131">www.wago.com/2002-131</a>
	<b>Item no.: 2002-161</b> Adaptor; gray	<a href="http://www.wago.com/2002-161">www.wago.com/2002-161</a>
Marker		
	<b>Item no.: 2009-115/000-002</b> WMB-Inline; for Smart Printer; 1500 pieces on roll; stretchable 5 - 5.2 mm; plain; snap-on type; yellow	<a href="http://www.wago.com/2009-115/000-002">www.wago.com/2009-115/000-002</a>
	<b>Item no.: 2009-115/000-007</b> WMB-Inline; for Smart Printer; 1500 pieces on roll; stretchable 5 - 5.2 mm; plain; snap-on type; gray	<a href="http://www.wago.com/2009-115/000-007">www.wago.com/2009-115/000-007</a>
	<b>Item no.: 2009-115/000-017</b> WMB-Inline; for Smart Printer; 1500 pieces on roll; stretchable 5 - 5.2 mm; plain; snap-on type; light green	<a href="http://www.wago.com/2009-115/000-017">www.wago.com/2009-115/000-017</a>
	<b>Item no.: 2009-115/000-023</b> WMB-Inline; for Smart Printer; 1500 pieces on roll; stretchable 5 - 5.2 mm; plain; snap-on type; green	<a href="http://www.wago.com/2009-115/000-023">www.wago.com/2009-115/000-023</a>
	<b>Item no.: 2009-115/000-024</b> WMB-Inline; for Smart Printer; 1500 pieces on roll; stretchable 5 - 5.2 mm; plain; snap-on type; violet	<a href="http://www.wago.com/2009-115/000-024">www.wago.com/2009-115/000-024</a>
	<b>Item no.: 2009-145/000-006</b> Mini-WSB Inline; for Smart Printer; 1700 pieces on roll; stretchable 5 - 5.2 mm; plain; snap-on type; blue	<a href="http://www.wago.com/2009-145/000-006">www.wago.com/2009-145/000-006</a>
	<b>Item no.: 2009-145</b> Mini-WSB Inline; for Smart Printer; 1700 pieces on roll; stretchable 5 - 5.2 mm; plain; snap-on type; white	<a href="http://www.wago.com/2009-145">www.wago.com/2009-145</a>
	<b>Item no.: 2009-145/000-002</b> Mini-WSB Inline; for Smart Printer; 1700 pieces on roll; stretchable 5 - 5.2 mm; plain; snap-on type; yellow	<a href="http://www.wago.com/2009-145/000-002">www.wago.com/2009-145/000-002</a>
	<b>Item no.: 2009-145/000-007</b> Mini-WSB Inline; for Smart Printer; 1700 pieces on roll; stretchable 5 - 5.2 mm; plain; snap-on type; gray	<a href="http://www.wago.com/2009-145/000-007">www.wago.com/2009-145/000-007</a>

Subject to changes. Please also observe the further product documentation!

	<b>Item no.: 2009-145/000-005</b> Mini-WSB Inline; for Smart Printer; 1700 pieces on roll; stretchable 5 - 5.2 mm; plain; snap-on type; red	<a href="http://www.wago.com/2009-145/000-005">www.wago.com/2009-145/000-005</a>
	<b>Item no.: 2009-145/000-012</b> Mini-WSB Inline; for Smart Printer; 1700 pieces on roll; stretchable 5 - 5.2 mm; plain; snap-on type; orange	<a href="http://www.wago.com/2009-145/000-012">www.wago.com/2009-145/000-012</a>
	<b>Item no.: 2009-145/000-023</b> Mini-WSB Inline; for Smart Printer; 1700 pieces on roll; stretchable 5 - 5.2 mm; plain; snap-on type; green	<a href="http://www.wago.com/2009-145/000-023">www.wago.com/2009-145/000-023</a>
	<b>Item no.: 2009-145/000-024</b> Mini-WSB Inline; for Smart Printer; 1700 pieces on roll; stretchable 5 - 5.2 mm; plain; snap-on type; violet	<a href="http://www.wago.com/2009-145/000-024">www.wago.com/2009-145/000-024</a>
	<b>Item no.: 2009-115</b> WMB-Inline; for Smart Printer; 1500 pieces on roll; stretchable 5 - 5.2 mm; plain; snap-on type; white	<a href="http://www.wago.com/2009-115">www.wago.com/2009-115</a>
	<b>Item no.: 248-501/000-006</b> Mini-WSB marking card; as card; not stretchable; plain; snap-on type; blue	<a href="http://www.wago.com/248-501/000-006">www.wago.com/248-501/000-006</a>
	<b>Item no.: 248-501/000-007</b> Mini-WSB marking card; as card; not stretchable; plain; snap-on type; gray	<a href="http://www.wago.com/248-501/000-007">www.wago.com/248-501/000-007</a>
	<b>Item no.: 248-501/000-002</b> Mini-WSB marking card; as card; not stretchable; plain; snap-on type; yellow	<a href="http://www.wago.com/248-501/000-002">www.wago.com/248-501/000-002</a>
	<b>Item no.: 248-501/000-012</b> Mini-WSB marking card; as card; not stretchable; plain; snap-on type; orange	<a href="http://www.wago.com/248-501/000-012">www.wago.com/248-501/000-012</a>
	<b>Item no.: 248-501</b> Mini-WSB marking card; as card; not stretchable; plain; snap-on type; white	<a href="http://www.wago.com/248-501">www.wago.com/248-501</a>
	<b>Item no.: 248-501/000-017</b> Mini-WSB marking card; as card; not stretchable; plain; snap-on type; light green	<a href="http://www.wago.com/248-501/000-017">www.wago.com/248-501/000-017</a>
	<b>Item no.: 248-501/000-005</b> Mini-WSB marking card; as card; not stretchable; plain; snap-on type; red	<a href="http://www.wago.com/248-501/000-005">www.wago.com/248-501/000-005</a>

Subject to changes. Please also observe the further product documentation!



**Item no.:** 248-501/000-024

Mini-WSB marking card; as card; not stretchable; plain; snap-on type; violet

[www.wago.com/248-501/000-024](http://www.wago.com/248-501/000-024)



**Item no.:** 248-501/000-023

Mini-WSB marking card; as card; not stretchable; plain; snap-on type; green

[www.wago.com/248-501/000-023](http://www.wago.com/248-501/000-023)

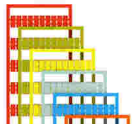

**Item no.:** 793-5501/000-007

WMB marking card; as card; for terminal block width 5 - 17.5 mm; stretchable 5 - 5.2 mm; plain; snap-on type; gray

[www.wago.com/793-5501/000-007](http://www.wago.com/793-5501/000-007)

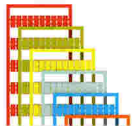

**Item no.:** 793-5501/000-012

WMB marking card; as card; for terminal block width 5 - 17.5 mm; stretchable 5 - 5.2 mm; plain; snap-on type; orange

[www.wago.com/793-5501/000-012](http://www.wago.com/793-5501/000-012)

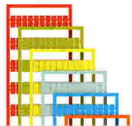

**Item no.:** 793-5501/000-014

WMB marking card; as card; for terminal block width 5 - 17.5 mm; stretchable 5 - 5.2 mm; plain; snap-on type; brown

[www.wago.com/793-5501/000-014](http://www.wago.com/793-5501/000-014)



**Item no.:** 793-5501/000-017

WMB marking card; as card; for terminal block width 5 - 17.5 mm; stretchable 5 - 5.2 mm; plain; snap-on type; green

[www.wago.com/793-5501/000-017](http://www.wago.com/793-5501/000-017)

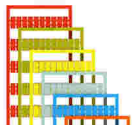

**Item no.:** 793-5501/000-023

WMB marking card; as card; for terminal block width 5 - 17.5 mm; stretchable 5 - 5.2 mm; plain; snap-on type; light green

[www.wago.com/793-5501/000-023](http://www.wago.com/793-5501/000-023)

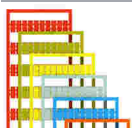

**Item no.:** 793-5501/000-024

WMB marking card; as card; for terminal block width 5 - 17.5 mm; stretchable 5 - 5.2 mm; plain; snap-on type; violet

[www.wago.com/793-5501/000-024](http://www.wago.com/793-5501/000-024)

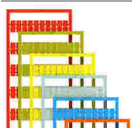

**Item no.:** 793-501/000-002

WMB marking card; as card; not stretchable; plain; snap-on type; yellow

[www.wago.com/793-501/000-002](http://www.wago.com/793-501/000-002)



**Item no.:** 793-501/000-007

WMB marking card; as card; not stretchable; plain; snap-on type; gray

[www.wago.com/793-501/000-007](http://www.wago.com/793-501/000-007)

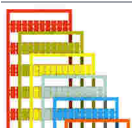

**Item no.:** 793-501/000-017

WMB marking card; as card; not stretchable; plain; snap-on type; light green

[www.wago.com/793-501/000-017](http://www.wago.com/793-501/000-017)

Subject to changes. Please also observe the further product documentation!

WAGO Kontakttechnik GmbH & Co. KG

Hansastr. 27

32423 Minden

Phone: +49571 887-0 | Fax: +49571 887-169

Email: [info.de@wago.com](mailto:info.de@wago.com) | Web: [www.wago.com](http://www.wago.com)

Do you have any questions about our products?

We are always happy to take your call at 01788 568 008.



**Item no.: 793-501/000-012**  
WMB marking card; as card; not stretchable; plain; snap-on type; orange

[www.wago.com/793-501/000-012](http://www.wago.com/793-501/000-012)



**Item no.: 793-501/000-023**  
WMB marking card; as card; not stretchable; plain; snap-on type; green

[www.wago.com/793-501/000-023](http://www.wago.com/793-501/000-023)



**Item no.: 793-501/000-006**  
WMB marking card; as card; not stretchable; plain; snap-on type; blue

[www.wago.com/793-501/000-006](http://www.wago.com/793-501/000-006)



**Item no.: 793-501/000-005**  
WMB marking card; as card; not stretchable; plain; snap-on type; red

[www.wago.com/793-501/000-005](http://www.wago.com/793-501/000-005)



**Item no.: 793-501**  
WMB marking card; as card; not stretchable; plain; snap-on type; white

[www.wago.com/793-501](http://www.wago.com/793-501)

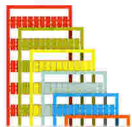

**Item no.: 793-501/000-024**  
WMB marking card; as card; not stretchable; plain; snap-on type; violet

[www.wago.com/793-501/000-024](http://www.wago.com/793-501/000-024)



**Item no.: 793-5501/000-005**  
WMB marking card; as card; for terminal block width 5 - 17.5 mm; stretchable 5 - 5.2 mm; plain; snap-on type; red

[www.wago.com/793-5501/000-005](http://www.wago.com/793-5501/000-005)



**Item no.: 793-5501/000-002**  
WMB marking card; as card; for terminal block width 5 - 17.5 mm; stretchable 5 - 5.2 mm; plain; snap-on type; yellow

[www.wago.com/793-5501/000-002](http://www.wago.com/793-5501/000-002)



**Item no.: 793-5501/000-006**  
WMB marking card; as card; for terminal block width 5 - 17.5 mm; stretchable 5 - 5.2 mm; plain; snap-on type; blue

[www.wago.com/793-5501/000-006](http://www.wago.com/793-5501/000-006)



**Item no.: 793-5501**  
WMB marking card; as card; for terminal block width 5 - 17.5 mm; stretchable 5 - 5.2 mm; plain; snap-on type; white











[www.wago.com/793-5501](http://www.wago.com/793-5501)



**Item no.: 2009-115/000-012**  
WMB-Inline; for Smart Printer; 1500 pieces on roll; stretchable 5 - 5.2 mm; plain; snap-on type; orange

[www.wago.com/2009-115/000-012](http://www.wago.com/2009-115/000-012)

Subject to changes. Please also observe the further product documentation!

	<b>Item no.: 2009-115/000-006</b> WMB-Inline; for Smart Printer; 1500 pieces on roll; stretchable 5 - 5.2 mm; plain; snap-on type; blue	<a href="http://www.wago.com/2009-115/000-006">www.wago.com/2009-115/000-006</a>
	<b>Item no.: 2009-115/000-005</b> WMB-Inline; for Smart Printer; 1500 pieces on roll; stretchable 5 - 5.2 mm; plain; snap-on type; red	<a href="http://www.wago.com/2009-115/000-005">www.wago.com/2009-115/000-005</a>
<b>Group marker carrier</b>		
	<b>Item no.: 2009-193</b> Group marker carrier	<a href="http://www.wago.com/2009-193">www.wago.com/2009-193</a>
	<b>Item no.: 2009-192</b> Group marker carrier	<a href="http://www.wago.com/2009-192">www.wago.com/2009-192</a>
	<b>Item no.: 2009-191</b> Group marker carrier	<a href="http://www.wago.com/2009-191">www.wago.com/2009-191</a>
<b>Insulation stop</b>		
Insulation stop		
	<b>Item no.: 2002-171</b> Insulation stop; 0.25 - 0.5 mm <sup>2</sup> ; 5 pieces/strip; light gray	<a href="http://www.wago.com/2002-171">www.wago.com/2002-171</a>
	<b>Item no.: 2002-172</b> Insulation stop; 0.75 - 1 mm <sup>2</sup> ; 5 pieces/strip; dark gray	<a href="http://www.wago.com/2002-172">www.wago.com/2002-172</a>
<b>Protective warning marker</b>		
Cover		
	<b>Item no.: 2002-115</b> Protective warning marker; with high-voltage symbol, black; for 5 terminal blocks; yellow	<a href="http://www.wago.com/2002-115">www.wago.com/2002-115</a>
<b>Tool</b>		
Operating tool		
	<b>Item no.: 210-658</b> Operating tool; Blade: 3.5 x 0.5 mm; with a partially insulated shaft; angled; short; multicoloured	<a href="http://www.wago.com/210-658">www.wago.com/210-658</a>
	<b>Item no.: 210-720</b> Operating tool; Blade: 3.5 x 0.5 mm; with a partially insulated shaft; multicoloured	<a href="http://www.wago.com/210-720">www.wago.com/210-720</a>
<b>Push-in type wire jumper</b>		
Jumper		
	<b>Item no.: 2009-412</b> Push-in type wire jumper; insulated; 60 mm long; black	<a href="http://www.wago.com/2009-412">www.wago.com/2009-412</a>
	<b>Item no.: 2009-414</b> Push-in type wire jumper; 1.5 mm <sup>2</sup> ; insulated; 110 mm long; black	<a href="http://www.wago.com/2009-414">www.wago.com/2009-414</a>
	<b>Item no.: 2009-416</b> Push-in type wire jumper; 1.5 mm <sup>2</sup> ; insulated; 250 mm long; black	<a href="http://www.wago.com/2009-416">www.wago.com/2009-416</a>
		

Subject to changes. Please also observe the further product documentation!



Item no.: 2009-414/000-005

Push-in type wire jumper; 1.5 mm<sup>2</sup>; insulated; 110 mm long; black

[www.wago.com/2009-414/000-005](http://www.wago.com/2009-414/000-005)



Item no.: 2009-414/000-006

Push-in type wire jumper; insulated; 110 mm long; black

[www.wago.com/2009-414/000-006](http://www.wago.com/2009-414/000-006)

## Downloads

### Documentation

#### Bid Text

2002-3204 X81 - Datei	Apr 18, 2019	xml 4.4 kB	Download
--------------------------	--------------	---------------	----------

2002-3204 docx - Datei	Apr 18, 2019	docx 16.1 kB	Download
---------------------------	--------------	-----------------	----------

#### Additional Information

Technical explanations	Apr 3, 2019	pdf 2.2 MB	Download
------------------------	-------------	---------------	----------

## CAD/CAE-Data

### CAD data

2D/3D Models 2002-3204		URL	Download
------------------------	--	-----	----------

### CAE data

WSCAD Universe 2002-3204		URL	Download
--------------------------	--	-----	----------

ZUKEN Portal 2002-3204		URL	Download
------------------------	--	-----	----------

EPLAN Data Portal 2002-3204		URL	Download
-----------------------------	--	-----	----------

## Environmental Product Compliance

### Compliance Search

Environmental Product Compliance 2002-3204		URL	Download
--	--	-----	----------

Subject to changes. Please also observe the further product documentation!

Triple-deck terminal block; Through/through/through terminal block; N/N/N; without marker carrier; for Ex e II and Ex i applications; for DIN-rail 35 x 15 and 35 x 7.5; 2.5 mm<sup>2</sup>; Push-in CAGE CLAMP®; 2,50 mm<sup>2</sup>; blue

## Installation Notes

### Conductor termination

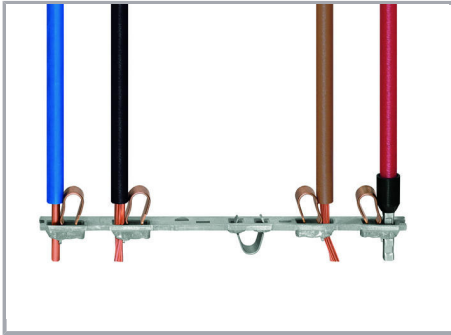

All conductor types at a glance

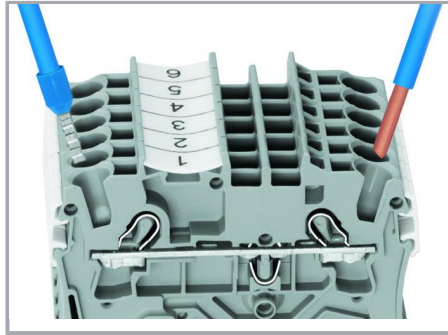

Push-in termination of solid and ferruled conductors

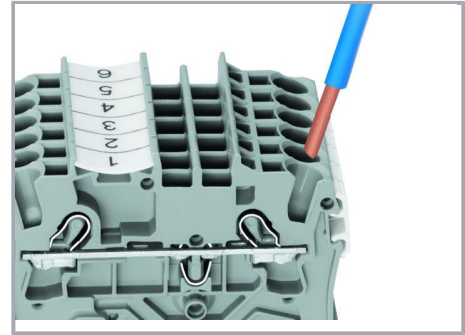

Inserting a conductor via push-in termination:

Solid conductors with cross-sections from either one size above, or up to two sizes below, the rated cross-section can be simply pushed in – no tools needed.

Subject to changes. Please also observe the further product documentation!



**Inserting a conductor via operating tool:**

**Conductor termination – insulation stop**

Connecting fine-stranded conductors without ferrules, or small cross-sectional conductors that cannot be pushed in, is performed similarly to the original CAGE CLAMP® – just use an operating tool.

**Advantage:**

To open the clamp, the operating tool is inserted vertically. The conductor entry is less than 15 degrees for easier wiring.

**Commoning**

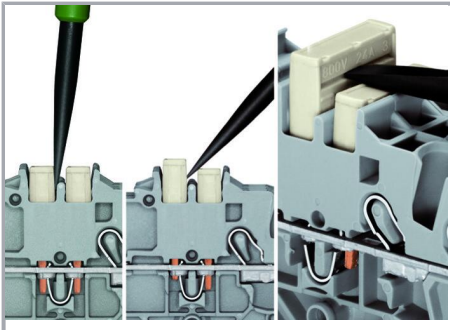

**Removing a push-in type jumper bar:**

Insert the operating tool between the jumper and partition wall of the dual jumper slots, then lift up the jumper.

Place the operating tool in the center of jumpers for up to five contacts (see above), or alternately on both sides for jumpers with more than five contacts.

Subject to changes. Please also observe the further product documentation!



The push-in type jumper bar system is based on the common plug and socket principle. Each terminal block is spring-loaded with a double socket and a resilient CrNi steel spring. The jumper contact material is pure electrolytic copper, which allows for an extremely small design capable of carrying the full-rated current of the terminal block. Ground terminal blocks can also be commoned using the same jumper system. Custom jumpers are created by breaking and removing jumper contacts (2000, 2001, 2002, 2004 Series).

### Commoning

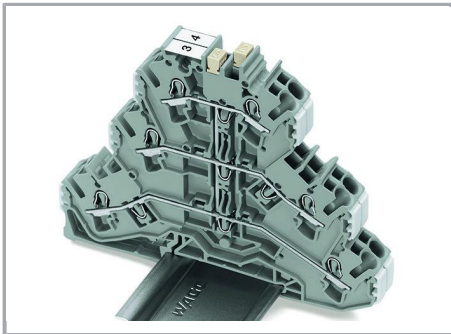

Commoning three levels via triple-deck vertical jumper (2002-493).



Created for double- and triple-deck TOPJOB® S Terminal Blocks, the vertical jumpers can common two or three levels. Clearly marked numerals ("2" and "3") distinguish the double-deck (2002-0492) and triple-deck vertical jumpers (2002-0493), even when inserted.

### Product family

#### TOPJOB® S

Subject to changes. Please also observe the further product documentation!



TOPJOB® S: In various industrial applications and modern building installations, WAGO's wide and versatile range of rail-mount terminal blocks provides more than just reliable electrical connections.

[Show all products from the family](#)

Subject to changes. Please also observe the further product documentation!

---

WAGO Kontakttechnik GmbH & Co. KG  
Hansastr. 27  
32423 Minden  
Phone: +49571 887-0 | Fax: +49571 887-169  
Email: [info.de@wago.com](mailto:info.de@wago.com) | Web: [www.wago.com](http://www.wago.com)

Do you have any questions about our products?  
We are always happy to take your call at 01788 568 008.