

## Data sheet | Item number: 207-1332

Gelbox; for cables; Branch; with gel; 221, 2273 Series; without splicing connectors; Size 2; gray

[www.wago.com/207-1332](http://www.wago.com/207-1332)

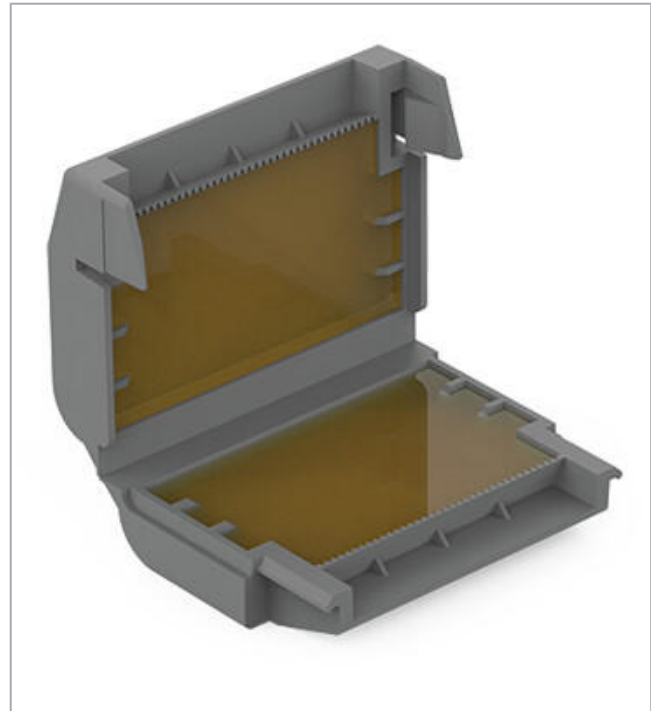
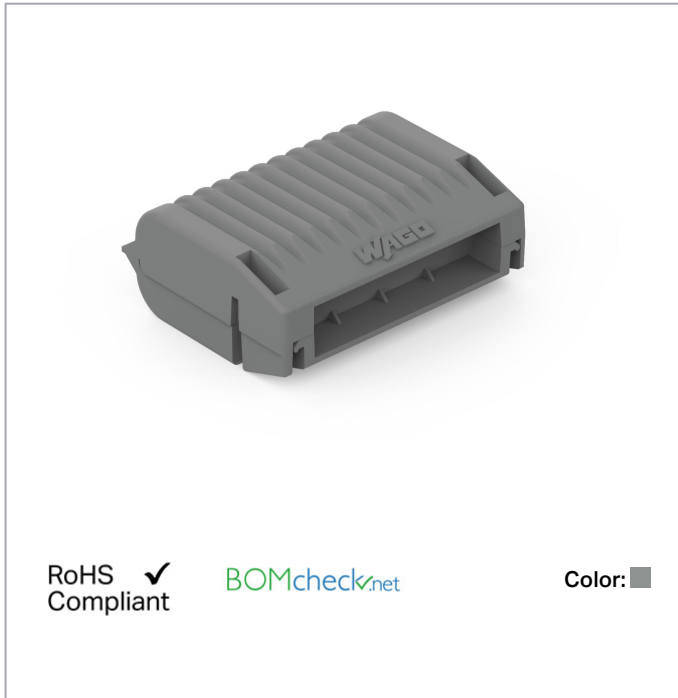

### Item description

Please note the system description for the splicing connectors that can be used.

The Benefits for You:

- Easy, fast and safe to use
- Can be used immediately and accessed again later
- Silicon-free
- Label-free
- Suitable for indefinite storage
- The complete system consisting of Gelboxes and WAGO connectors has been VDE-tested and IPX8-certified.

### Data

#### Connection data

Actuation type

Verrastung

Subject to changes. Please also observe the further product documentation!

WAGO Kontakttechnik GmbH & Co. KG  
Hansastr. 27  
32423 Minden  
Phone: +49571 887-0 | Fax: +49571 887-169  
Email: [info.de@wago.com](mailto:info.de@wago.com) | Web: [www.wago.com](http://www.wago.com)

Do you have any questions about our products?  
We are always happy to take your call at 01788 568 008.

## Physical data

|        |                      |
|--------|----------------------|
| Width  | 33.6 mm / 1.323 inch |
| Height | 17.8 mm / 0.701 inch |
| Depth  | 45.9 mm / 1.807 inch |

## Mechanical data

|                 |                          |
|-----------------|--------------------------|
| Mounting type   | Fliegende Verbindung     |
| Protection type | IPx8 (2m/2h) gemäß 60529 |

## Material Data

|                  |              |
|------------------|--------------|
| Color            | gray         |
| Housing material | Polypropylen |
| Weight           | 18.4 g       |

## Environmental Requirements

|   |               |
|---|---------------|
| Surrounding air temperature (operation) | -55 ... 85 °C |
| Surrounding air temperature (storage)   | 0 ... 40 °C   |

## Commercial data

|                       |               |
|-----------------------|---------------|
| Packaging type        | BOX           |
| Country of origin     | IT            |
| GTIN                  | 4055143998017 |
| Customs tariff number | 85389099990   |

## Approvals / Certificates

### Country specific Approvals

| Logo   | Approval                                     | Additional Approval Text | Certificate name |
|--|--|--------------------------|------------------|
|  | VDE<br>VDE Prüf- und Zertifizierungsinstitut | EN 60998                 | 400051938        |

## Counterpart

Subject to changes. Please also observe the further product documentation!

WAGO Kontakttechnik GmbH & Co. KG  
 Hansastr. 27  
 32423 Minden  
 Phone: +49571 887-0 | Fax: +49571 887-169  
 Email: [info.de@wago.com](mailto:info.de@wago.com) | Web: [www.wago.com](http://www.wago.com)

Do you have any questions about our products?  
 We are always happy to take your call at 01788 568 008.

## Downloads

### Documentation

#### Additional Information

|                        |             |               |          |
|------------------------|-------------|---------------|----------|
| Technical explanations | 03-Apr-2019 | pdf<br>2.1 MB | Download |
|------------------------|-------------|---------------|----------|

#### System Description

|   |             |               |          |
|---|-------------|---------------|----------|
| System Description 207 Series Gel boxes | 31-Jul-2020 | pdf<br>1.1 MB | Download |
|---|-------------|---------------|----------|

## Installation Notes

### Installation

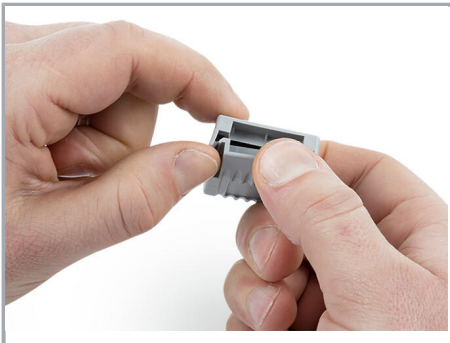

Gelbox öffnen.

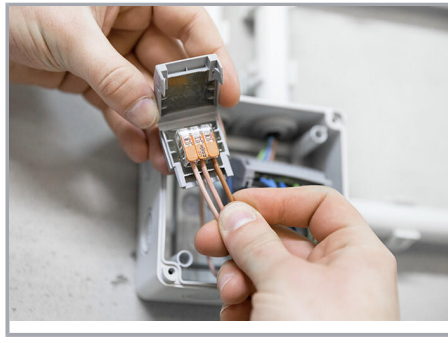

Verdrahtete Klemme in die Gelbox einlegen.

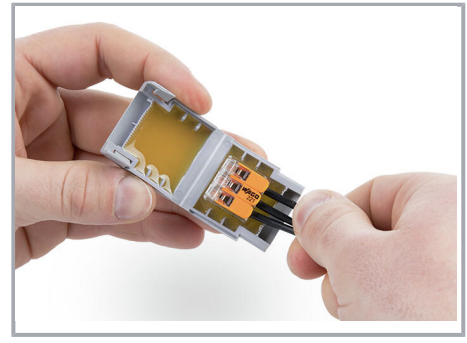

Verdrahtete Klemme in die Gelbox einlegen.

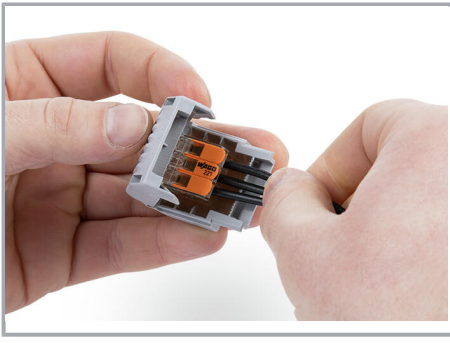

Gelbox schließen.

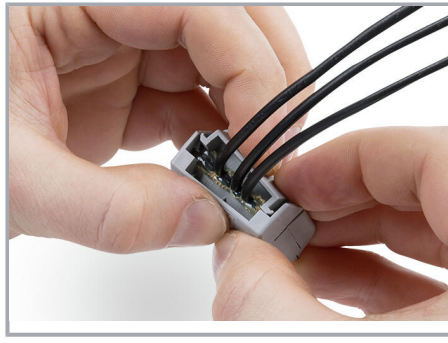

Verrastung sicher verschließen.

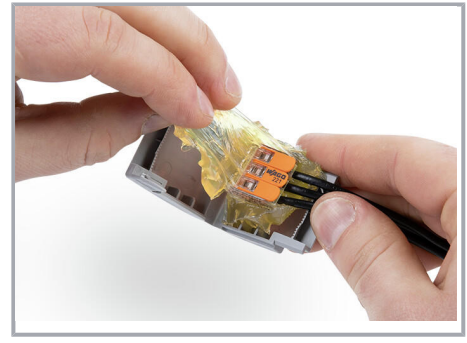

Wiederzugänglich:

- Gelbox öffnen
- Gel entfernen
- Umverdrahten mit neuen Komponenten

Subject to changes. Please also observe the further product documentation!