

Data sheet | Item number: 207-1331

Gelbox; for cables; Branch; with gel; 221, 2273 Series; without splicing connectors; Size 1; gray

www.wago.com/207-1331

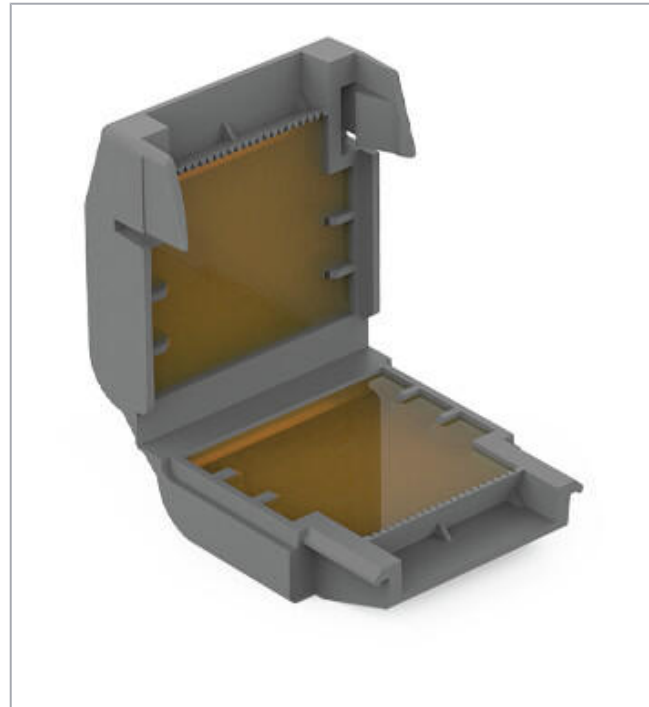

Item description

Please note the system description for the splicing connectors that can be used.

The Benefits for You:

- Easy, fast and safe to use
- Can be used immediately and accessed again later
- Silicon-free
- Label-free
- Suitable for indefinite storage
- The complete system consisting of Gelboxes and WAGO connectors has been VDE-tested and IPX8-certified.

Data

Connection data

Actuation type

Verrastung

Subject to changes. Please also observe the further product documentation!

WAGO Kontakttechnik GmbH & Co. KG
Hansastr. 27
32423 Minden
Phone: +49571 887-0 | Fax: +49571 887-169
Email: info.de@wago.com | Web: www.wago.com

Do you have any questions about our products?
We are always happy to take your call at 01788 568 008.

Physical data

Width	33.6 mm / 1.323 inch
Height	17.8 mm / 0.701 inch
Depth	32 mm / 1.26 inch

Mechanical data

Mounting type	Fliegende Verbindung
Protection type	IPx8 (2m/2h) gemäß 60529

Material Data

Color	gray
Housing material	Polypropylen
Weight	12.7 g

Environmental Requirements

Surrounding air temperature (operation)	-55 ... 85 °C
Surrounding air temperature (storage)	0 ... 40 °C

Commercial data

Packaging type	BOX
Country of origin	IT
GTIN	4055143997799
Customs tariff number	85389099990

Approvals / Certificates

Country specific Approvals

Logo	Approval	Additional Approval Text	Certificate name
	VDE VDE Prüf- und Zertifizierungsinstitut	EN 60998	400051938

Counterpart

Subject to changes. Please also observe the further product documentation!

WAGO Kontakttechnik GmbH & Co. KG
 Hansastr. 27
 32423 Minden
 Phone: +49571 887-0 | Fax: +49571 887-169
 Email: info.de@wago.com | Web: www.wago.com

Do you have any questions about our products?
 We are always happy to take your call at 01788 568 008.

Downloads

Documentation

Additional Information

Technical explanations	03-Apr-2019	pdf 2.1 MB	Download
------------------------	-------------	---------------	----------

System Description

System Description 207 Series Gel boxes	31-Jul-2020	pdf 1.1 MB	Download
---	-------------	---------------	----------

Installation Notes

Installation



Gelbox öffnen.

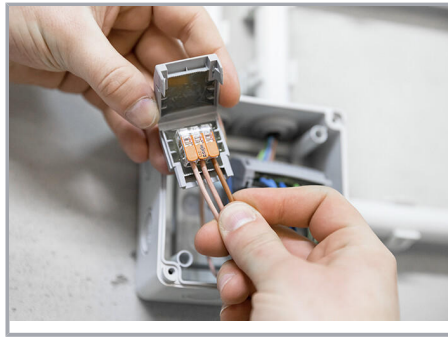

Verdrahtete Klemme in die Gelbox einlegen.

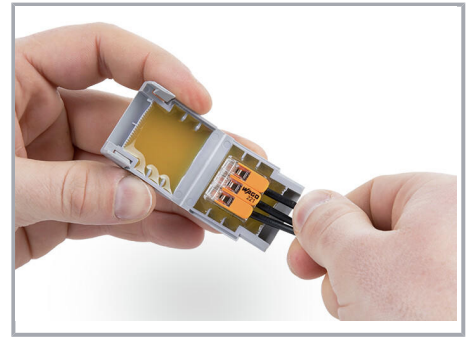

Verdrahtete Klemme in die Gelbox einlegen.

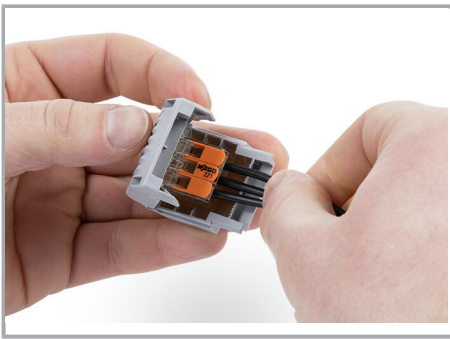

Gelbox schließen.

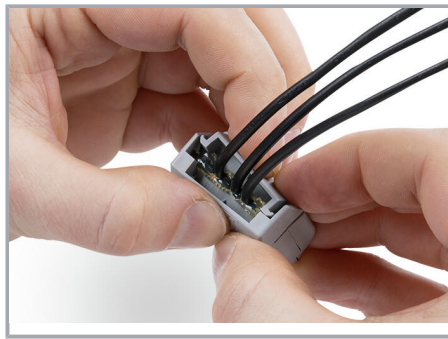

Verrastung sicher verschließen.

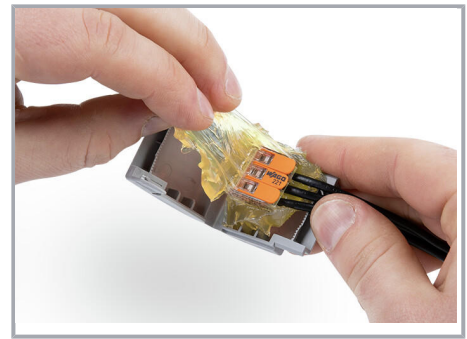

Wiederzugänglich:

- Gelbox öffnen
- Gel entfernen
- Umverdrahten mit neuen Komponenten

Subject to changes. Please also observe the further product documentation!