

1SNK522020R0000 ✓ ACTIVE

ENTRELEC

TE Internal #: 1SNK522020R0000

Modular Terminal Blocks, Feed-Through, Screw Clamp Terminal Block, 00AWG Rated Cross Section, 70mm<sup>2</sup> Rated Cross Section, Blue

[View on TE.com >](#)



Connectors > Terminal Blocks & Strips > Modular Terminal Blocks



Block Function: **Feed-Through**

Modular Terminal Block Product Type: **Screw Clamp Terminal Block**

Rated Cross Section: **70 mm<sup>2</sup>**

Primary Product Color: **Blue**

## Features

### Product Type Features

Modular Terminal Block Product Type	Screw Clamp Terminal Block
-------------------------------------	----------------------------

### Configuration Features

Gauge Type	B11
Number of Levels	1
Number of Circuits	1
Block Function	Feed-Through
Number of Positions	2

### Electrical Characteristics

Impulse Withstanding Voltage Rating (IEC)	8000 V
Power Loss	6.1 W
Short-Time Withstanding Current Rating @ 1s	8400 A
Voltage Rating (IEC)	1000 V
Operating Voltage Rating (UL & CSA) (Max) - Main Circuit	1000 V
Dielectric Test Voltage	2200 V
Current Rating (UL)	159 A
Current Rating (IEC)	192 A

### Body Features

Product Weight	158.1 g[6.224 oz]
----------------	-------------------



Primary Product Color	Blue
-----------------------	------

### Mechanical Attachment

DIN Rail Mounting Type	TH35-15, TH35-7.5
Connector Mounting Type	DIN Rail

### Housing Features

Housing Material	Polyamide
------------------	-----------

### Dimensions

Main Circuit Capacity - Twin Ferrule per Screw Clamp	6 AWG
Main Circuit Capacity - 1 Flexible Conductor per Screw Clamp	16 – 70 mm <sup>2</sup>
Main Circuit Capacity - 1 Insulated Ferrule per Screw Clamp	16 – 50 mm <sup>2</sup>
Main Circuit Capacity - 1 Non-Insulated Ferrule per Screw Clamp	16 – 50 mm <sup>2</sup>
Main Circuit Capacity - 2 Flexible Conductors per Screw Clamp	16 – 35 mm <sup>2</sup>
Main Circuit Capacity - 1 Rigid Stranded Conductor per Screw Clamp	4 – 00 AWG
Wire Stripping Length	25 mm[.984 in]
Main Circuit Capacity - 2 Rigid Stranded Conductors per Screw Clamp	16 – 35 mm <sup>2</sup>
Tool Size	6 mm[.236 in]
Product Depth	75.4 mm
Product Length	75.35 mm[2.97 in]
Product Height	74 mm
Rated Cross Section	70 mm <sup>2</sup>
Product Spacing	22 mm[.866 in]

### Usage Conditions

Storage Temperature Range	-55 – 110 °C[-67 – 230 °F]
Installation Temperature Range	-5 – 40 °C[23 – 104 °F]
Operating Temperature Range	-55 – 110 °C[-67 – 230 °F]

### Industry Standards

UL Flammability Rating	UL 94V-0
------------------------	----------

### Product Compliance

For compliance documentation, visit the product page on [TE.com](https://www.te.com)>





EU RoHS Directive 2011/65/EU	Compliant
------------------------------	-----------

EU ELV Directive 2000/53/EC	Compliant
China RoHS 2 Directive MIIT Order No 32, 2016	No Restricted Materials Above Threshold
EU REACH Regulation (EC) No. 1907/2006	Current ECHA Candidate List: JUL 2021 (219) Candidate List Declared Against: JAN 2021 (211) SVHC > Threshold: Not Yet Reviewed
Halogen Content	Low Halogen - Br, Cl, F, I < 900 ppm per homogenous material. Also BFR/CFR/PVC Free
Solder Process Capability	Not reviewed for solder process capability

Product Compliance Disclaimer

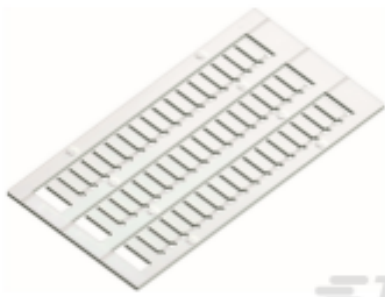
This information is provided based on reasonable inquiry of our suppliers and represents our current actual knowledge based on the information they provided. This information is subject to change. The part numbers that TE has identified as EU RoHS compliant have a maximum concentration of 0.1% by weight in homogenous materials for lead, hexavalent chromium, mercury, PBB, PBDE, DBP, BBP, DEHP, DIBP, and 0.01% for cadmium, or qualify for an exemption to these limits as defined in the Annexes of Directive 2011/65/EU (RoHS2). Finished electrical and electronic equipment products will be CE marked as required by Directive 2011/65/EU. Components may not be CE marked. Additionally, the part numbers that TE has identified as EU ELV compliant have a maximum concentration of 0.1% by weight in homogenous materials for lead, hexavalent chromium, and mercury, and 0.01% for cadmium, or qualify for an exemption to these limits as defined in the Annexes of Directive 2000/53/EC (ELV). Regarding the REACH Regulation, the information TE provides on SVHC in articles for this part number is based on the latest European Chemicals Agency (ECHA) 'Guidance on requirements for substances in articles' posted at this URL: <https://echa.europa.eu/guidance-documents/guidance-on-reach>

## Compatible Parts

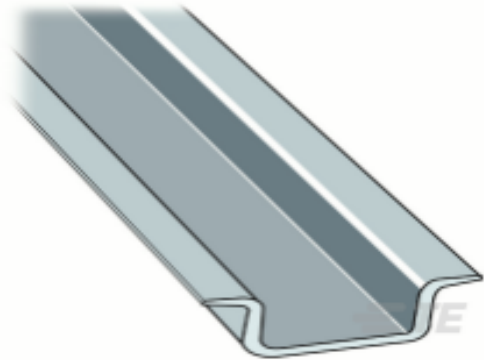
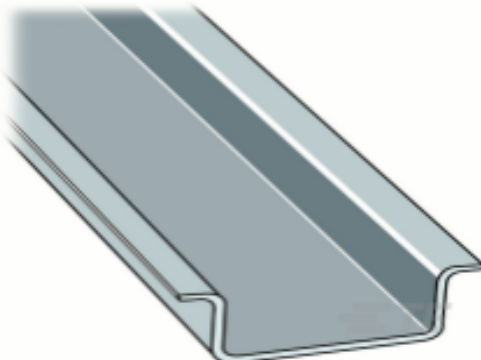
 <p>TE Part # 1SNK160000R0000 MC812</p>	 <p>TE Part # 1SNK169999R0000 MC812PA</p>	 <p>TE Part # 1SNK900102R0000 BAZH1</p>	 <p>TE Part # 1SNK900611R0000 UMH</p>
 <p>TE Part # 1SNA164800R0300 PR3.G2</p>	 <p>TE Part # 1SNA168500R1200 PR4</p>	 <p>TE Part # 1SNA168700R2200 PR5</p>	 <p>TE Part # 1SNA173220R0500 PR30</p>



### Customers Also Bought

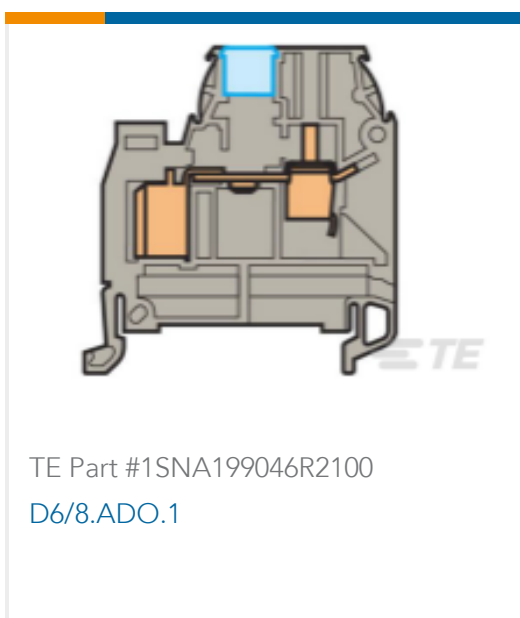
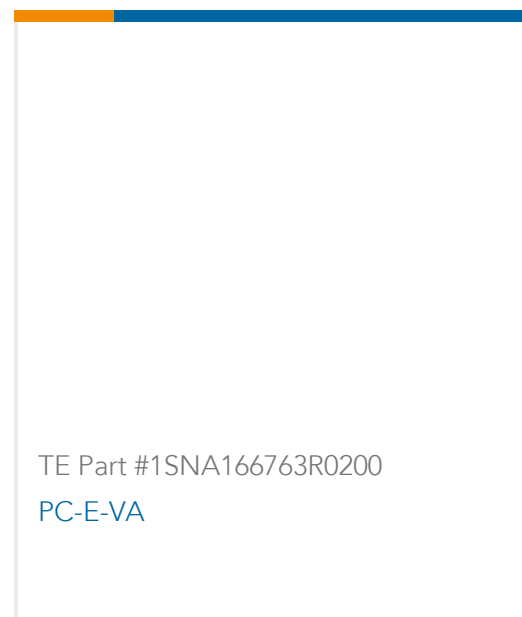
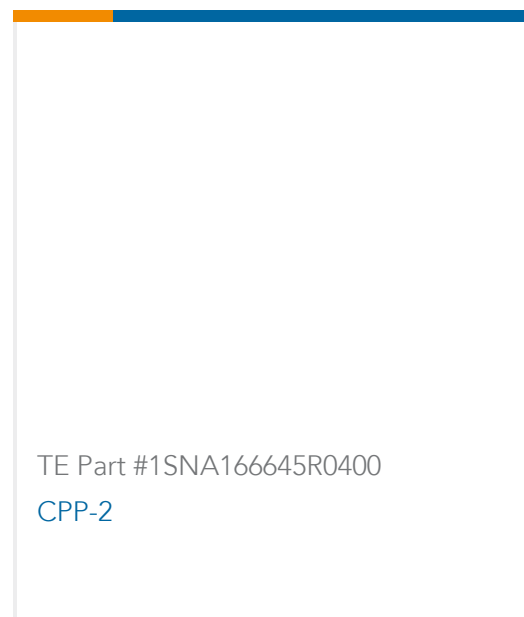

### Documents



### CAD Files

#### 3D PDF

3D

#### Customer View Model

[ENG\\_CVM\\_CVM\\_1SNK522020R0000\\_A.2d\\_dxf.zip](#)

English

#### Customer View Model

[ENG\\_CVM\\_CVM\\_1SNK522020R0000\\_A.3d\\_igs.zip](#)

English

#### Customer View Model

[ENG\\_CVM\\_CVM\\_1SNK522020R0000\\_A.3d\\_stp.zip](#)

English

By downloading the CAD file I accept and agree to the [Terms and Conditions](#) of use.

### Datasheets & Catalog Pages

[ENTRELEC Terminal Block - Master Catalog](#)

English

[ZS70-BL](#)

English

[SNK SERIES TERMINAL BLOCKS](#)

English

[ENTRELEC Terminal Blocks Catalogue \(RUS\)](#)

### Agency Approvals

[CE Declaration of Conformity](#)

English