

1SNA105004R2200 ✓ ACTIVE

TE Internal #: 1SNA105004R2200

Modular Terminal Blocks, Feed-Through, Screw Clamp Terminal Block, 8AWG Rated Cross Section, 6mm² Rated Cross Section, Orange

[View on TE.com >](#)



Connectors > Terminal Blocks & Strips > Modular Terminal Blocks



Block Function: **Feed-Through**

Modular Terminal Block Product Type: **Screw Clamp Terminal Block**

Rated Cross Section: **6 mm²**

Primary Product Color: **Orange**

Features

Product Type Features

Modular Terminal Block Product Type	Screw Clamp Terminal Block
-------------------------------------	----------------------------

Configuration Features

Gauge Type	A5
Number of Levels	1
Number of Poles	2
Number of Circuits	1
Block Function	Feed-Through
Number of Positions	2

Electrical Characteristics

Operating Voltage Rating (UL & CSA) (Max) - Main Circuit	600 V
Impulse Withstanding Voltage Rating (IEC)	8000 V
Voltage Rating (CSA)	600 V
Current Rating (CSA)	50 A
Dielectric Test Voltage	2000 V
Short-Time Withstanding Current Rating @ 1s	720 A
Voltage Rating (IEC)	1000 V
Current Rating (UL)	50 A
Current Rating (IEC)	41 A
Voltage Rating	1000 VAC



Body Features

Product Weight	12.8 g[.451 oz]
Primary Product Color	Orange

Termination Features

Termination Method to Wire & Cable	Screw Terminal
------------------------------------	----------------

Mechanical Attachment

DIN Rail Mounting Type	G32, TH35-15, TH35-7.5
Tightening Torque	7.1 in-lbs
Connector Mounting Type	DIN Rail

Housing Features

Housing Material	Polyamide 6.6
------------------	---------------

Dimensions

Main Circuit Capacity - 1 Rigid Stranded Conductor per Screw Clamp	.5 – 10 mm ²
Wire Stripping Length	12 mm[.472 in]
Main Circuit Capacity - 1 Flexible Conductor per Spring Clamp	.5 – 6 mm ²
Product Depth	40.5 mm
Product Width	8 mm[.314 in]
Product Length	40.5 mm
Product Height	44.5 mm
Rated Cross Section	6 mm ²
Product Spacing	8 mm[.314 in]
Wire Size	6 mm ²

Usage Conditions

Storage Temperature Range	-55 – 110 °C[-67 – 230 °F]
Installation Temperature Range	-5 – 40 °C[23 – 104 °F]
Operating Temperature Range	-55 – 110 °C[-67 – 230 °F]

Operation/Application

Circuit Application	Signal
---------------------	--------

Industry Standards

IP Rating	IP20
UL Flammability Rating	UL 94V-0



Product Compliance

[For compliance documentation, visit the product page on TE.com>](#)

EU RoHS Directive 2011/65/EU	Compliant
EU ELV Directive 2000/53/EC	Compliant
China RoHS 2 Directive MIIT Order No 32, 2016	No Restricted Materials Above Threshold
EU REACH Regulation (EC) No. 1907/2006	Current ECHA Candidate List: JUL 2021 (219) Candidate List Declared Against: JAN 2021 (211) SVHC > Threshold: Not Yet Reviewed
Halogen Content	Low Halogen - Br, Cl, F, I < 900 ppm per homogenous material. Also BFR/CFR/PVC Free
Solder Process Capability	Not reviewed for solder process capability

Product Compliance Disclaimer

This information is provided based on reasonable inquiry of our suppliers and represents our current actual knowledge based on the information they provided. This information is subject to change. The part numbers that TE has identified as EU RoHS compliant have a maximum concentration of 0.1% by weight in homogenous materials for lead, hexavalent chromium, mercury, PBB, PBDE, DBP, BBP, DEHP, DIBP, and 0.01% for cadmium, or qualify for an exemption to these limits as defined in the Annexes of Directive 2011/65/EU (RoHS2). Finished electrical and electronic equipment products will be CE marked as required by Directive 2011/65/EU. Components may not be CE marked. Additionally, the part numbers that TE has identified as EU ELV compliant have a maximum concentration of 0.1% by weight in homogenous materials for lead, hexavalent chromium, and mercury, and 0.01% for cadmium, or qualify for an exemption to these limits as defined in the Annexes of Directive 2000/53/EC (ELV). Regarding the REACH Regulation, the information TE provides on SVHC in articles for this part number is based on the latest European Chemicals Agency (ECHA) 'Guidance on requirements for substances in articles' posted at this URL: <https://echa.europa.eu/guidance-documents/guidance-on-reach>

Compatible Parts



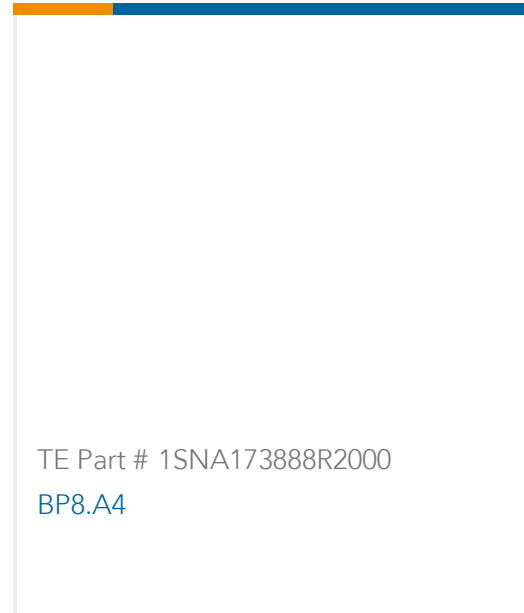
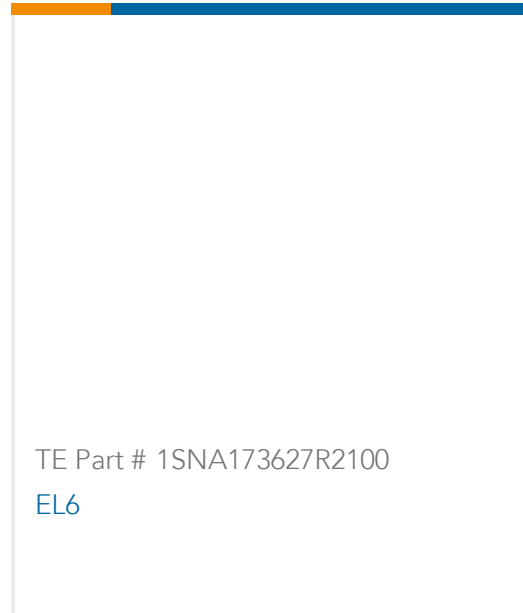
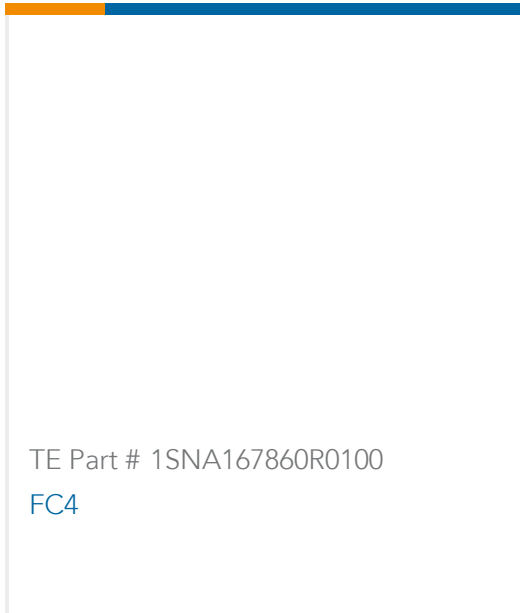
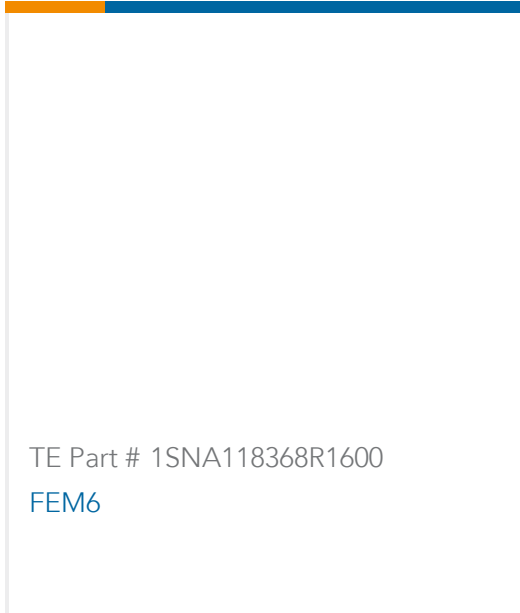
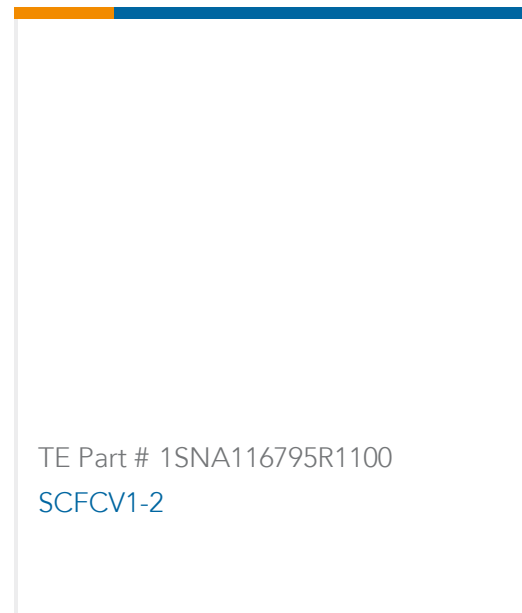
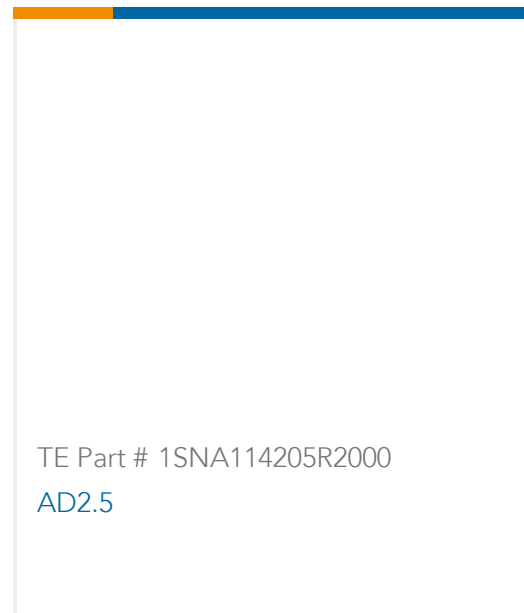
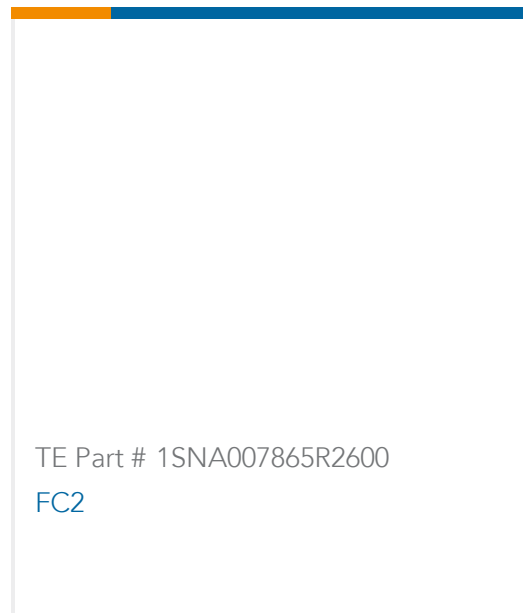
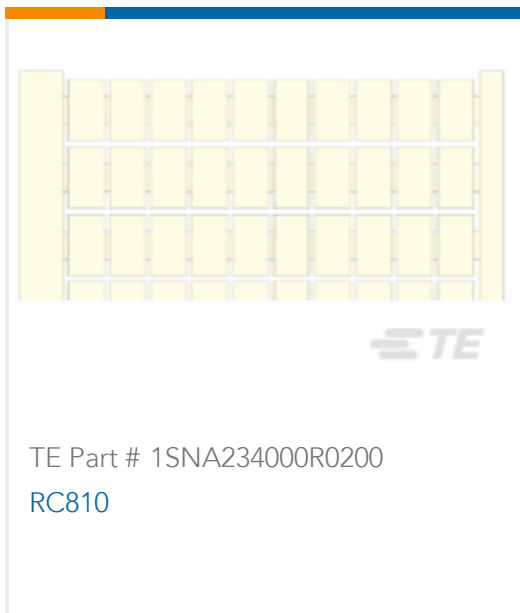

Customers Also Bought

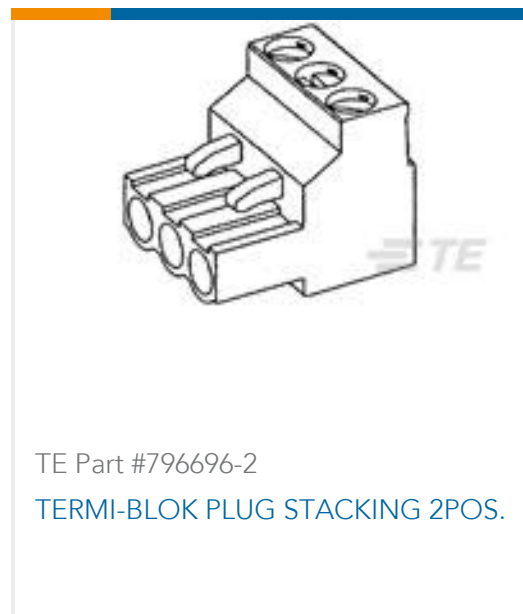
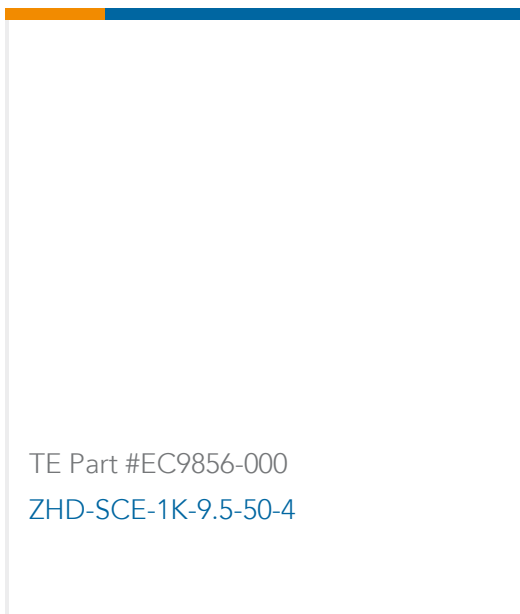

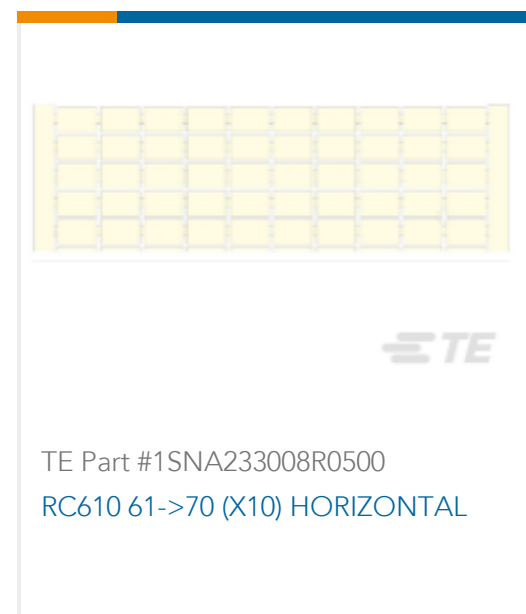
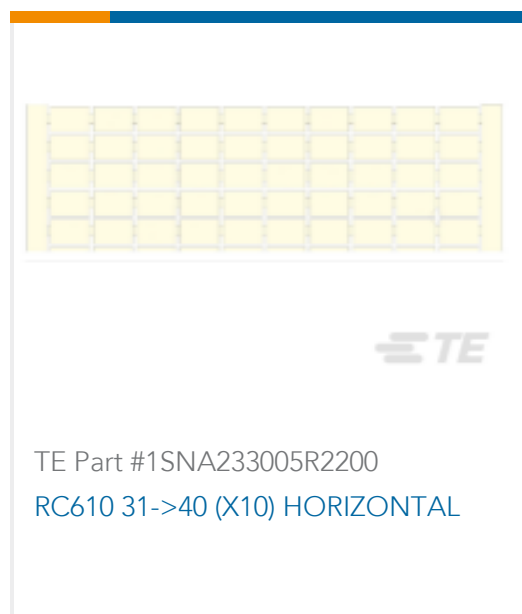

Documents

CAD Files

3D PDF

3D

Customer View Model

[ENG_CVM_CVM_1SNA105004R2200_A.2d_dxf.zip](#)

English

Customer View Model

[ENG_CVM_CVM_1SNA105004R2200_A.3d_igs.zip](#)

English

Customer View Model

[ENG_CVM_CVM_1SNA105004R2200_A.3d_stp.zip](#)

English

By downloading the CAD file I accept and agree to the [Terms and Conditions](#) of use.

Datasheets & Catalog Pages

M6/8

English

[ENTRELEC Terminal Blocks Catalogue \(RUS\)](#)

Product Environmental Compliance

Product Compliance

English

Product Compliance

English